

ROBIT® ROCKTOOLS PRODUCT CATALOGUE

Catalogue de Produits · Catálogo de Productos · Каталог

- Drifting and tunnelling
- Reaming equipment
- Bench and production drilling
- Shank adapters
- Auxiliary tools



ROBIT® ROCKTOOLS **PRODUCT CATALOGUE**

Copyright © 2016 by Robit Plc

All rights reserved. No part of this catalogue may be reproduced or transmitted in any form or by any means, electronic or mechanical, including photocopying, recording, or by any information storage and retrieval system, without written permission from the publisher.

Trademarks

Robit is a trademark of Robit Plc

Publisher

Robit Plc

www.robit.fi



Printed: June 2016

Robit reserves all rights to any changes in the products and the specifications without prior notice.

CONTENTS

Sommaire · Contenido · Содержание



ROBIT IN BRIEF · Robit en Bref · Robit en resumen · Несколько слов о компании Robit	4
PRODUCT LINES · Lignes de produits · Línea de productos · Номенклатура продукции	6
ROBIT CODES · Codes Robit · Códigos Robit · Коды Robit	8
ROCKTOOLS · Rocktools · Herramientas para perforación en roca · Буровой инструмент	14
Drifting and tunnelling · Perçage de tunnels et galeries · Perforación de túneles y galerías · Проходка горных выработок	14
Reaming equipment · Equipement d'alésage · Herramientas para escariar · Расширительный инструмент	30
Bench and production drilling · Forage en gradins et production · Perforación de banco y producción · Бурение промышленных взрывных скважин на открытых и подземных горных работах	34
Shank adapters · Emmanchement · Zancos · Хвостовики	58
Auxiliary tools · Accessoires · Accesorios · Вспомогательный инструмент	80
Guide adapters · Guides adapteurs · Adaptadores guía · Направляющие адаптеры	82
Button bit adapters · Adaptateurs pour taillants à boutons · Adaptadores para broca · Адаптеры к штыревым коронкам	83
Couplings · Manchons · Coples · Муфты	84
Grinding cups · Meules d'affûtage · Copas de afilado · Заточные колпачки	86
INDEX · Index · Índice · Спецификации	88

ROBIT IN BRIEF

Robit en Bref · Robit en resumen · Несколько слов о компании Robit

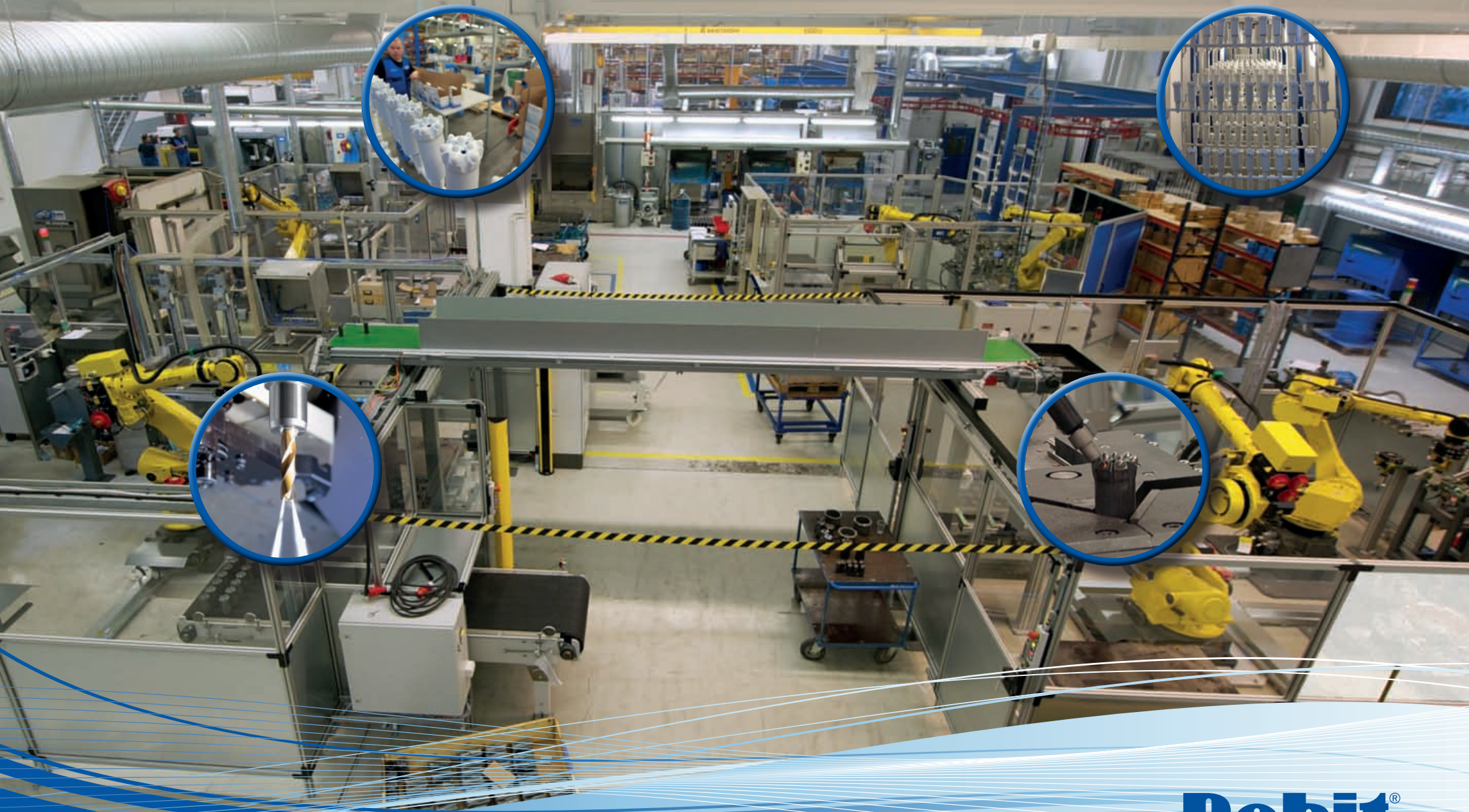



 Since 1985 Robit® has been in the front line of drilling business providing high quality drilling tools for mines, quarries and construction sites around the world. Having its roots in Finnish mining industry Robit® masters the knowledge of drilling in the most challenging rock types. Still it drives to utilize the experience of the end users to develop even better products with best materials and high precision manufacturing process. Widespread global dealer network guarantees that even the smallest countries receive best customer service available. More holes – more value for the customer has always been the driving force of Robit Plc – the company with faces.

 Depuis sa création en 1985 Robit® a toujours été à l'avant-garde du monde du forage en proposant des outils de forage de haute qualité aux mines, carrières et au monde du génie civil et de la construction et ce dans le monde entier. Puisant ses racines dans l'industrie minière Finlandaise, Robit® possède le savoir-faire pour forer les roches les plus exigeantes. Ayant pour philosophie un développement constant de ses produits, Robit®, en travaillant avec des foreurs du monde entier, allie un design spécifique avec des matériaux de haute qualité et un processus de fabrication de très haute précision. Son réseau mondial de distributeur très étendu et garantit à chaque pays, même les plus petits, le meilleur service client disponible. Plus de trous – Plus de bénéfices pour le client a toujours été la force motrice de Robit Plc – La société à visages humains.

 Desde el año 1985 Robit® ha estado a la vanguardia de la industria de perforaciones proporcionando herramientas de alta calidad para la perforación en minas, canteras y sitios en construcción alrededor del mundo. Teniendo sus raíces en la industria minera finlandesa, Robit® domina la perforación de los más exigentes tipos de roca. Aun así, tiende a utilizar la experiencia de sus usuarios para mejorar sus productos utilizando los mejores materiales y un proceso de fabricación de alta precisión. Su extensa red mundial de distribuidores garantiza el mejor servicio disponible incluso para los países más pequeños. Más perforación - mayor beneficio para el cliente, ha sido siempre la fuerza motriz de Robit Plc – Compañía con personal enfocado al servicio.

 С 1985 года компания Robit® производит высококлассные буровые инструменты для рудников, карьеров и строительства для заказчиков по всему миру. Компания Robit®, выросшая в недрах финской горной промышленности имеет большой опыт в производстве горных инструментов для самых сложных горно-геологических условий. Компания Robit® работает в сотрудничестве с конечными заказчиками и использует их опыт для совершенствования своей продукции, используя в процессе ее изготовления высококлассный материал и высокоточные инструменты. Широкая дилерская сеть по всему миру гарантирует, что наши заказчики даже в небольших странах получают высококлассное обслуживание. Больше набуренных метров при более низкой стоимости девиз компании Robit Plc.

PRODUCT LINES

Lignes de produits · Línea de productos · Номенклатура продукции





Rocktools - Button bits

Rocktools product line covers all construction, quarrying, and mining drill&blast applications from soft to hardest rock conditions. Tunnelling is one of the most important customer segments for Robit® bits, and applications like drifting, cuthole and bolthole are well covered. Also major mining and quarrying customers have approved Robit® quality worldwide.

Ground drilling tools – Casing Systems

Robit® Casing Systems are the key components of the Ground Drilling Tools product line. Its patented locking system enables easy and reliable drilling cost effectively. Robit® Casing Systems have several references worldwide in all major ground drilling applications: forepoling, anchoring, piling and underpinning, horizontal drilling, water and thermal well drilling, soil investigation/ monitoring and underwater drilling.



Rocktools – Taillants à boutons

La ligne de produits Rocktools couvre toutes les applications de la construction, carrières, mines, tunnels, etc... depuis les terrains les plus tendres aux conditions de roches les plus extrêmes. Le monde du tunnel est l'un des segments les plus importants pour les taillants Robit® avec par exemple le creusement de galeries, le boulonnage, les trous de décompression ... Les clients des mines et des carrières les plus exigeantes au monde ont depuis longtemps approuvé la qualité des taillants Robit®.

Ground drilling tools – Système de tubage à l'avancement

Le Système de Tubage Robit® est un composant clé de la ligne de produits Ground Drilling Tools (outils pour terrains de recouvrement). Son système breveté d'enclenchement du pilote et de la bague assure un forage simple et fiable avec des coûts de forage efficaces. Le système de tubage Robit® est utilisé dans le monde entier avec des références dans toutes les applications pour terrains de recouvrement: voûtes parapluies, ancrage, pieux et underpinning, forage horizontal, puits pour l'eau et la géothermie, reconnaissance des sols, forages sous-marin.



Herramientas para perforación en roca – Brocas de botones

La línea de productos de Rocktools cubre todas las aplicaciones en construcciones, canteras y minería en la perforación y explosión de roca blanda y rocas de extrema dureza. Los túneles son uno de los más importantes segmentos de clientes para las brocas Robit® además de las aplicaciones para perforación de galerías, perforación para formar piedras o piezas de concreto y perforación para el anclaje. También los principales clientes de minería y canteras han aprobado la calidad de Robit® en todo el mundo.

Herramientas para perforación de terrenos – Sistemas de tuberías

Los sistemas de tuberías de Robit® son los componentes claves de la línea de productos de herramientas para la perforación de terrenos. Su sistema patentado para acoplar el piloto con la corona permite una perforación fácil y fiable con costo efectivo. Los sistemas de tuberías de Robit® tienen varias referencias en todo el mundo en todas las principales aplicaciones de perforaciones en tierra como: tubos de paraguas, anclaje, pilotaje y recalzado de cimientos, perforación horizontal, perforación de pozos de agua y pozos térmicos, investigación y monitoreo del suelo y perforación subacuática.



Буровой инструмент для горных работ Штыревые коронки

Номенклатура продукции компании Robit® включает в себя горные инструменты для строительства, карьеров и рудников при буровзрывных работах в условиях от слабых до самых крепких горных пород. Проходка горных выработок большого сечения один из самых важных секторов для коронок Робит, также они применяются при бурении врубных шпуров и бурении шпуров для установки штанг. Качество продукции Робит одобряют заказчики по всему миру.

Буровой инструмент специального назначения

Robit® Casing Systems (система бурения с обсадными трубами) - основная составляющая буровых инструментов для специального бурения в ассортименте продукции Робит. Эта надежная запатентованная система обеспечивает эффективность проведения буровых работ. Robit® Casing Systems применяется по всему миру для следующих работ: Укрепление грунтов, Анкерное бурение, Бурение под установку свай, Горизонтальное бурение, Бурение водяных и термических скважин, Исследования и мониторинг почвы, Бурение под водой, Буровой инструмент специального назначения.



ROBIT® CODES

Codes Robit® · Códigos Robit® · Коды Robit®



Green Steel

All of the Robit® button bits are manufactured of new 100% recyclable steel. In the environmentally friendly steel production process the CO₂ emissions have been reduced 80% and 95% of the waste is recycled including the process smoke which is filtered. The new steel grade gives even more uniform properties and improved fatigue strength which is crucial in rock drilling process.



Green Steel

L'ensemble des taillants à boutons Robit® est fabriqué dans un nouvel acier recyclable à 100%. Dans sa phase de production, l'acier "Green Steel" est aussi plus respectueux de l'environnement avec une réduction des émissions de CO₂ de 80% et un recyclage de 95% des déchets, y compris des fumées. La composition de ce nouvel acier plus uniforme offre des propriétés de résistance à la fatigue grandement améliorés; ce qui est cruciale dans tout processus de forage.



Green Steel

Todas las brocas de botones de Robit® son fabricadas de un acero nuevo 100% reciclable. Su proceso de fabricación es mucho más amigable con el medio ambiente ya que produce 80% menos de emisiones de CO₂ y el 95% de los desechos son reciclados incluyendo los humos generados durante su producción. El nuevo grado de acero tiene propiedades más uniformes y mejor resistencia de fatiga lo que es crucial en el proceso de perforación de la roca.



Green Steel

Все штыревые коронки Robit® произведены из новой стали, подлежащей 100% вторичной переработке или утилизации. Когда в процессе производства используется экологически безвредная сталь, выбросы углекислого газа уменьшаются на 80% и 95% отходов производства используется повторно, включая производственные выхлопы, которые фильтруются. Новая марка стали имеет более стабильные качественные характеристики и повышенный предел усталости, что является очень важным в процессе бурения.

Metric and Imperial system · Conversion métrique et impérial · Conversión entre métrico e imperial · Метрическая и британская системы

25 mm	1 inch	45 mm	1¾ inch	68 mm	2 ¹¹ / ₁₆ inch	115 mm	4½ inch
33 mm	1½ inch	48 mm	1⅞ inch	70 mm	2¾ inch	127 mm	5 inch
35 mm	1⅜ inch	51 mm	2 inch	76 mm	3 inch	140 mm	5½ inch
38 mm	1½ inch	58 mm	2¼ inch	89 mm	3½ inch	152 mm	6 inch
41 mm	1⅝ inch	60 mm	2⅜ inch	92 mm	3⅝ inch		
43 mm	1 ¹¹ / ₁₆ inch	64 mm	2½ inch	102 mm	4 inch		



Button bit codes · Codes des taillants à boutons · Códigos de brocas · Коды штыревых коронок

e.g	HTG	51 C	115 DS	R Ball.	
					<p>Button type · Type de boutons · Tipo de botones · Тип штырей = Ballistic buttons · Bouton balistique · Boton balístico · Баллистические штыри</p> <p>Body type · Type de jupe · Tipo de cuerpo · Тип корпуса = R (retrac)</p>
					<p>Bit model · Modèle de taillant · Modelo de broca · модель коронки = DS (drop center · centro deprimido · утопленный центр)</p> <p>Bit diameter · Diamètre du taillant · Diámetro de broca · диаметр коронки = 115 mm (4½")</p>
					<p>Thread type · Type de filetage · Tipo de rosca · Тип резьбы = C (T, FI, etc.)</p> <p>Thread size · Diamètre du filetage · Tamaño de rosca · Размер резьбы = 51 mm (2")</p>
					<p>Series code · Code série · Códig o de serie · Код серии = HTG</p>

Body types · Type de jupe · Tipo de cuerpo · Тип корпуса

Standard body

Jupe lisse · Cuerpo normal · Обычный корпус



Retrac body

Jupe retrac · Cuerpo retrac · Корпус "ретрак"





ROBIT® CODES

Codes Robit® · Códigos Robit® · Коды Robit®

Face types · Face types · Tipos de cara · Тип рабочей поверхности коронки

A = Basic model for medium and hard rock drilling

Modèle pour roche medium et dure · Modelo básico para roca media dura y dura · Модель для средних и крепких горных пород

B = Heavy duty model for abrasive conditions

Modèle grande résistance pour conditions abrasives · Modelo de gran resistencia para condiciones abrasivas · Модель для работы в жестких и абразивных условиях

S = Speed drilling model for various conditions

Pour forage rapide dans des conditions diverses · Para perforación rápida en condiciones diversas · Модель для быстрого бурения для различных условий

M = Maximized flushing properties for soft and medium hard rock

Propriétés de soufflage maximales pour roche tendre et medium · Propiedades con barrido máximo para roca suave y de media dureza · Модель с усиленной промывкой для слабых и средних горных пород

DS = Drop center model for straighter hole requirements in soft and medium hard rock

Modèle drop center pour plus de rectitude du forage pour roche tendre et medium · Centro deprimido para perforaciones más rectas en roca suave y de media dureza · Модель с утопленным центром для уменьшения отклонения бурового става при бурении скважин для слабых и средних горных пород

Drifting and tunnelling

Tunnels et galeries · Perforación de túneles y galerías · Проходка горных выработок

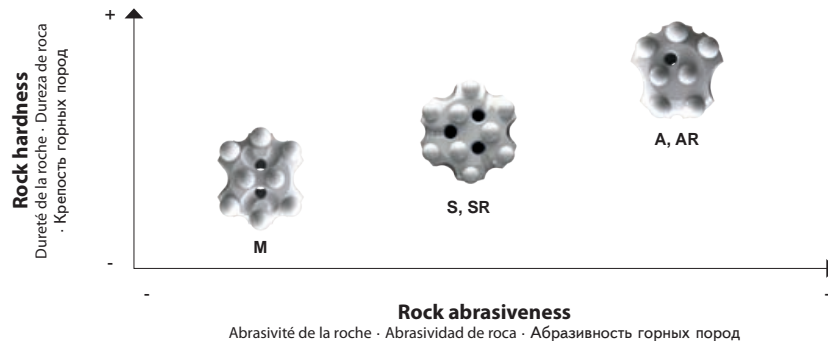

Bench and production drilling

Forage en gradins et production · Perforación de banco y producción · Бурение промышленных взрывных скважин на открытых и подземных горных работах

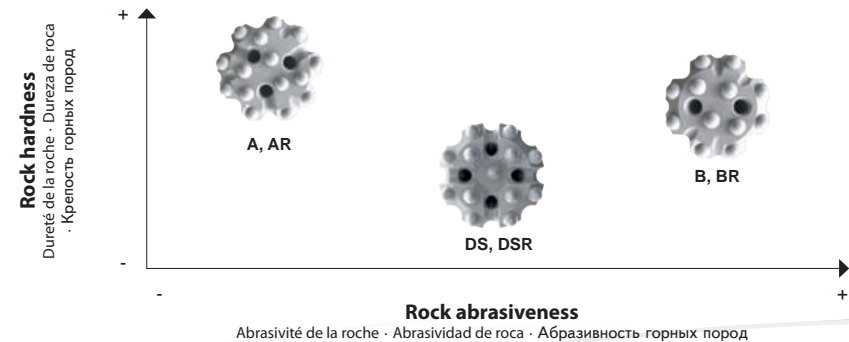



Buttons · Boutons · Botones · Штыри

All the products are available with ballistic or SuperDome buttons. · Tous les produits sont disponibles avec des boutons balistiques ou SuperDômes.

· Todos los productos estan disponibles con botones balísticos o SuperDomos. · Вся продукция поставляется или с баллистическими или с штырями SuperDome.



Ballistic button

Bouton balistique · Botón balístico · Баллистические штыри

SuperDome button

Bouton SuperDôme · Botón SuperDomo · Штыри SuperDome

Specifications · Spécifications · Especificaciones · Спецификации

Flushing grooves in face and on side

- Canaux de soufflage frontaux et latéraux
- Ranura de barrido en cara y periferia
- Промывочные канавки на лицевой и боковой поверхностях

Face and side flushing holes

- Orifices de soufflage frontaux et latéraux
- Orificios de barrido en cara y periferia
- Промывочные отверстия на лицевой и боковой поверхностях

High quality tungsten carbide = TC Standard or ballistic buttons

- Carbone de tungstène de qualité supérieure = TC Boutons Standards ou Balistiques
- Carburo de tungsteno de alta calidad = TC Botones estándar o balísticos
- Высококачественный карбид вольфрама - стандартные или баллистические штыри

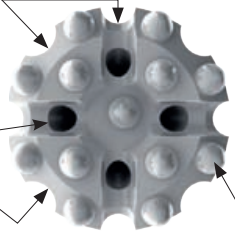

Gauge-button angle 30 - 35°

- Angle des boutons de la périphérie 30-35
- Ángulo de botón en periferia 30 - 35
- Угол наклона контурных штырей 30 - 35 град.

New optimal retrac hard top body

- Nouvelle jupe rétract "Hard Top"
- Nuevo cuerpo retráctil con propiedades mecánicas optimas
- Новый оптимальный корпус "ретрак" из высокопрочной стали

Wear resistant heat treated steel body made from high quality Scandinavian steel

- Corps en acier Scandinave de haute qualité traité pour une grande résistance à l'usure
- Cuerpo de acero con tratamiento térmico resistente al desgaste y hecho con el acero de la más alta calidad de origen escandinavo.
- Износостойкий термообработанный корпус из высококачественной Скандинавской стали

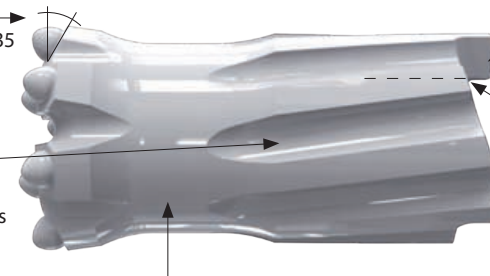

R - Retracs teeth

- R - Dents Retracs
- R - Dientes Retráctiles
- R - зубцы "ретрак"

Thread

- filetage
- rosca
- резьба



ROBIT® CODES

Codes Robit® · Códigos Robit® · Коды Robit®

Drill rod codes · Codes tiges · Códigos de barras · Каталогный номер буровой штанги

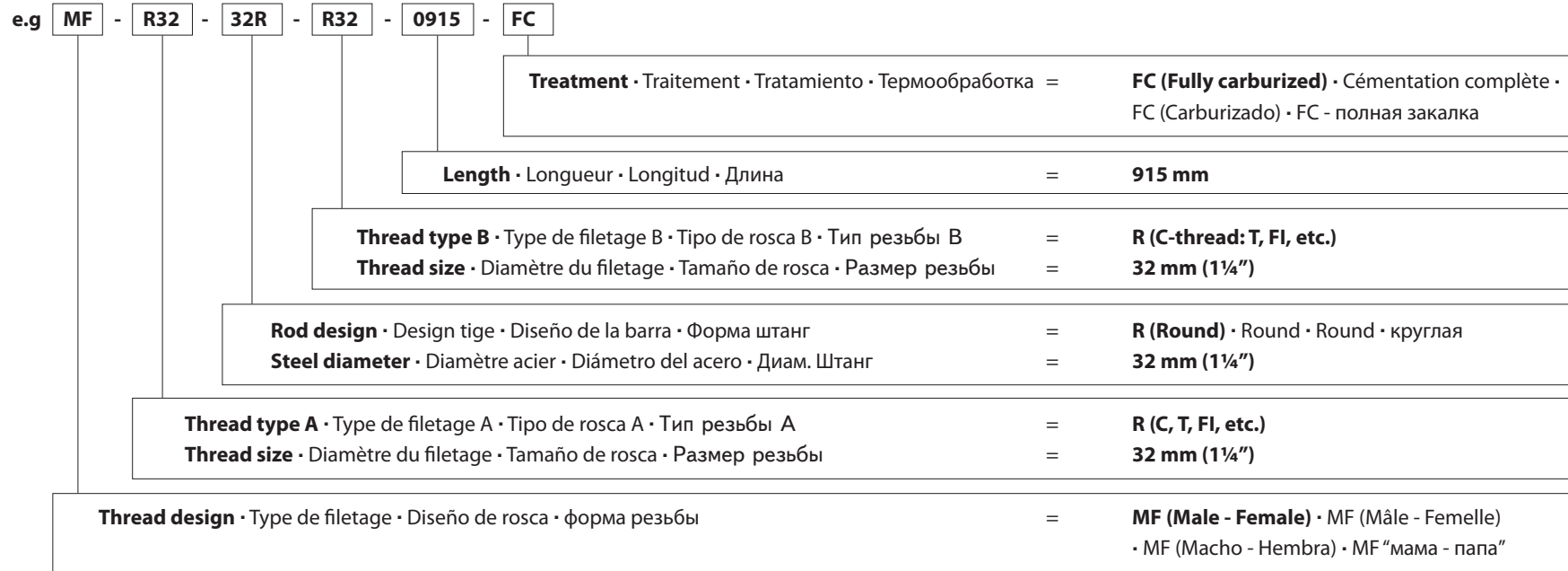

Thread type · Type de filetage · Tipo de rosca · Тип резьбы

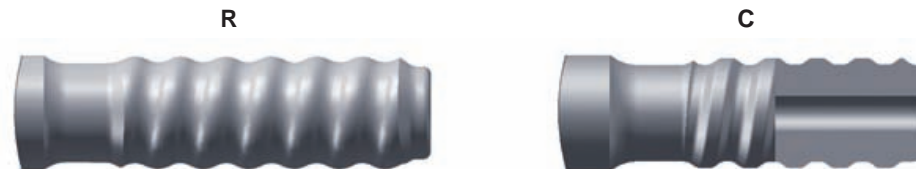

NOTES

DRIFTING AND TUNNELLING

Perçage de tunnels et galeries · Perforación de túneles y galerías · Проходка горных выработок





DRIFTING AND TUNNELLING

Perçage de tunnels et galeries · Perforación de túneles y galerías · Проходка горных выработок

Bolting - Drifting - Reaming

Boulonage - Perçage de galerie - Alésage · Anclaje - Perforación de galerías - Escariado
· Бурение для установки штанг (крепление анкерами) - Проходка - Расширение



MEDIUM AND HARD ROCK MODEL

Modèle pour roche medium et dure
Modelo para roca media dura y dura
Модель для средних и крепких пород

A, AR



ALL AROUND MODEL

Modèle pour conditions diverses
Modelo para condiciones diversas
Универсальная модель

S, SR

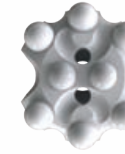

SOFT AND MEDIUM HARD ROCK MODEL

Modèles pour roche tendre et medium
Modelo para roca suave y media dura
Модель для средних и слабых пород

M



Please note: Face designs might vary depending on bit diameter.

Note: Le design des têtes peut varier selon le diamètre des taillants.
Nota: Los diseños de cara pueden variar dependiendo del diámetro de la broca.
Дизайн рабочей поверхности коронки также зависит от диаметра коронки.













R25 DRIFTING AND TUNNELLING - BITS

1" thread

Perçage de tunnels et galeries · Perforación de túneles y galerías · Проходка горных выработок



R25 (1") · threads · filetage · rosca · резьба

Order code	Diameter		Body	Gauge	Buttons		Flushing		Product number		Weight	Pcs/box
Code produit	Diamètre		Jupe	Périphérie	Boutons		Soufflage		Référence produit		Poids	Pcs/boite
Código del producto	Diámetro		Cuerpo	Periferia	Botones		Orificios de barrido		Referencia del producto		Peso	Pzas./caja
Модель	Диаметр		Корпус	Угол	Штыри		Промывочные отверстия		Номер продукции		Вес	Шт./упак.
	[mm]	[in]			 [No.] [mm]	 [No.] [mm]	 [No.]	 [No.]	 [SuperDome]	 [Ballistic]	[kg]	
HTG 25R35M	35	1 3/8"		30°	2 x 8	6 x 8	2	2	04-125-035-2362	04-125-035-2363	0,3	20
HTG 25R38M	38	1 1/2"		30°	2 x 8	6 x 8	2	2	04-125-038-2011	04-125-038-2012	0,5	15
HTG 25R41M	41	1 5/8"		35°	2 x 8	6 x 9	2	2	04-125-041-2178	04-125-041-2179	0,5	15



HTG 25R35M



HTG 25R38M



HTG 25R41M











BITS - DRIFTING AND TUNNELLING

R28

Perçage de tunnels et galeries · Perforación de túneles y galerías · Проходка горных выработок

1 1/8" thread

R28 (1 1/8") · threads · filetage · rosca · резьба

Order code	Diameter		Body	Gauge	Buttons		Flushing		Product number		Weight	Pcs/box		
Code produit	Diamètre		Jupe	Périphérie	Boutons		Soufflage		Référence produit		Poids	Pcs/boite		
Código del producto	Diámetro		Cuerpo	Periferia	Botones		Oficios de barrido		Referencia del producto		Peso	Pzas./caja		
Модель	Диаметр		Корпус	Угол	Штыри		Промывочные отверстия		Номер продукции		Вес	Шт./упак.		
	[mm]	[in]		↘	 [No.]	[mm]	 [No.]	[mm]	 [No.]	 [No.]	 [SuperDome]	 [Ballistic]	[kg]	
HTG 28R38M	38	1 1/2"		30°	2 x 8	6 x 8	2	2	04-128-038-2020	04-128-038-2021	0,5	15		
HTG 28R41M	41	1 5/8"		35°	2 x 8	6 x 9	2	2	04-128-041-2552	04-128-041-2618	0,5	10		



HTG 28R38M



HTG 28R41M

R32 DRIFTING AND TUNNELLING - BITS

1 1/4" thread

Perçage de tunnels et galeries · Perforación de túneles y galerías · Проходка горных выработок



R32 (1 1/4") · threads · filetage · rosca · резьба

Order code	Diameter		Body	Gauge	Buttons		Flushing		Product number		Weight	Pcs/box
Code produit	Diamètre		Jupe	Périphérie	Boutons		Soufflage		Référence produit		Poids	Pcs/boite
Código del producto	Diámetro		Cuerpo	Periferia	Botones		Orificios de barrido		Referencia del producto		Peso	Pzas./caja
Модель	Диаметр		Корпус	Угол	Штыри		Промывочные отверстия		Номер продукции		Вес	Шт./упак.
	[mm]	[in]			 [No.] [mm]	 [No.] [mm]	 [No.]	 [No.]	 [SuperDome]	 [Ballistic]	[kg]	
HTG 32R41M	41	1 5/8"		35°	2 x 8	6 x 9	2	2	04-132-041-2023	04-132-041-2024	0,5	10
HTG 32R43A	43	1 11/16"		35°	2 x 9	5 x 10	1	2	04-132-043-2029	04-132-043-2030	0,6	10
HTG 32R43S	43	1 11/16"		35°	3 x 8	6 x 9	3	2	04-132-043-3836	04-132-043-3837	0,7	10
HTG 32R45A	45	1 3/4"		30°	2 x 9	5 x 11	1	2	04-132-045-0329	04-132-045-0331	0,7	10
HTG 32R45S	45	1 3/4"		35°	3 x 8	6 x 9	3	1	04-132-045-3805	04-132-045-3806	0,7	10
HTG 32R45SR	45	1 3/4"		35°	3 x 8	6 x 9	3	1	04-132-045-3818	04-132-045-3819	0,9	10
HTG 32R48S	48	1 7/8"		35°	3 x 9	6 x 10	3	2	04-132-048-3815	04-132-048-3816	0,9	10
HTG 32R51A	51	2"		35°	2 x 10	7 x 10	2	2	04-132-051-0357	04-132-051-0359	1,0	10



HTG 32R41M



HTG 32R43A



HTG 32R43S



HTG 32R45A



HTG 32R45S



HTG 32R45SR



HTG 32R48S



HTG 32R51A







BITS - DRIFTING AND TUNNELLING

R32

Perçage de tunnels et galeries · Perforación de túneles y galerías · Проходка горных выработок

1 ¼" thread

R32 (1 ¼") · threads · filetage · rosca · резьба

Order code Code produit Código del producto Модель	Diameter		Body Juje Cuerpo Корпус	Gauge Périphérie Periferia Угол	Buttons		Flushing		Product number		Weight Poids Peso Вес	Pcs/box Pcs/boite Pzas./caja Шт./упак.
	[mm]	[in]			[No.]	[mm]	[No.]	[mm]	[No.]	[No.]		
HTG 32R51S	51	2"		35°	3 x 9	6 x 10	3	1	04-132-051-3821	04-132-051-3822	1,0	10
HTG 32R51SR	51	2"		35°	3 x 9	6 x 10	3	1	04-132-051-4590	04-132-051-4591	1,2	10
HTG 32R57S	57	2¼"		35°	3 x 10	6 x 11	3	1	04-132-057-5602	04-132-057-5603	1,3	10
HTG 32R64A	64	2½"		35°	4 x 10	8 x 10	2	-	04-132-064-2037	04-132-064-2038	1,7	5
HTG 32R64AR	64	2½"		35°	4 x 10	8 x 10	2	-	04-132-064-0385	04-132-064-0387	2,3	5
HTG 32R76B	76	3"		35°	4 x 11	8 x 11	2	-	04-132-076-0398	04-132-076-0400	2,3	5



HTG 32R51S



HTG 32R51SR



HTG 32R57S



HTG 32R64A



HTG 32R64AR



HTG 32R76B

R32 DRIFTING AND TUNNELLING - RODS

1 1/4" thread

Perçage de tunnels et galeries · Perforación de túneles y galerías · Проходка горных выработок

Drifter Rod · Tiges tunnels · Barras para Túneles · Перфораторная штанга - **R32 (1 1/4") bit thread** · filetage · rosca · резьба

Order code	Length	Diameter	Thread	Flushing	Product number	Weight	Pcs/box
Code produit	Longueur	Diamètre	Filetage	Soufflage	Référence produit	Poids	Pcs/boite
Código del producto	Longitud	Diámetro	Rosca	Orificios de barrido	Referencia del producto	Peso	Pzas./caja
Модель	Длина	Диаметр	Резьба	Промывочные отверстия	Номер продукции	Вес	Шт./упак.
	L	D	Thread		F		
	[mm] [ft - in]	[mm]	[A]	[B]	[mm]	[kg]	

Drifter Rod R38 - Hex32 - R32

MM-R38-32H-R32-3090	3090	10' 1 5/8"	HEX32	R38	R32	9,6	06D-07-2886	19,7	50
MM-R38-32H-R32-3700	3700	12' 1 5/8"	HEX32	R38	R32	9,6	06D-07-2887	23,6	40
MM-R38-32H-R32-4305	4305	14' 1 1/2"	HEX32	R38	R32	9,6	06D-07-2143	27,4	30

Drifter Rod R38 - Hex35 - R32

MM-R38-35H-R32-3090	3090	10' 1 5/8"	HEX35	R38	R32	9,5	06D-07-2892	23,9	50
MM-R38-35H-R32-3700	3700	12' 1 5/8"	HEX35	R38	R32	9,5	06D-07-2894	28,7	40
MM-R38-35H-R32-4305	4305	14' 1 1/2"	HEX35	R38	R32	9,5	06D-07-2709	33,5	30

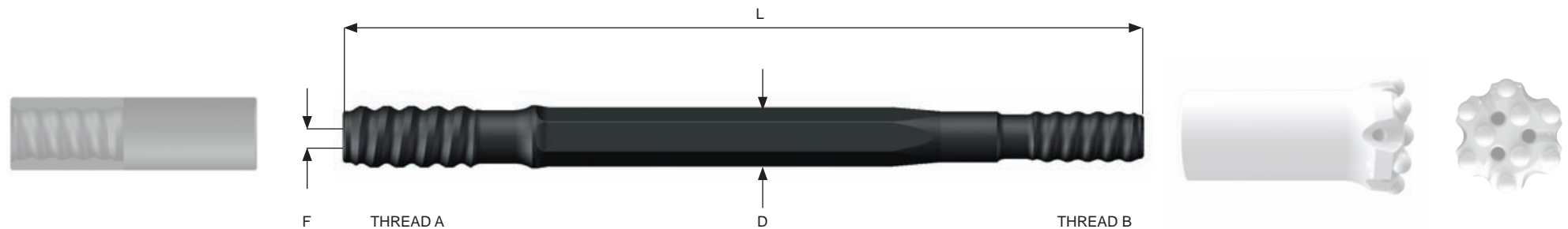

RODS - DRIFTING AND TUNNELLING

R32

Perçage de tunnels et galeries · Perforación de túneles y galerías · Проходка горных выработок

1 1/4" thread

Drifter Rod · Tiges tunnels · Barras para Túneles · Перфораторная штанга - **R32 (1 1/4") bit thread** · filetage · rosca · резьба

Order code	Length		Diameter	Thread		Flushing	Product number	Weight	Pcs/box
Code produit	Longueur		Diamètre	Filetage		Soufflage	Référence produit	Poids	Pcs/boite
Código del producto	Longitud		Diámetro	Rosca		Orificios de barrido	Referencia del producto	Peso	Pzas./caja
Модель	Длина		Диаметр	Резьба		Промывочные отверстия	Номер продукции	Вес	Шт./упак.
	L		D			F			
	[mm]	[ft - in]	[mm]	[A]	[B]	[mm]		[kg]	

Drifter Rod C38 - Hex32 - R32

MM-C38-32H-R32-3090	3090	10' 1 5/8"	HEX32	C38	R32	9,6	06D-07-2889	19,7	50
MM-C38-32H-R32-4305	4305	14' 1 1/2"	HEX32	C38	R32	9,6	06D-07-2750	27,4	30

Drifter Rod C38 - Hex35 - R32

MM-C38-35H-R32-3090	3090	10' 1 5/8"	HEX35	C38	R32	9,5	06D-07-2895	23,9	50
MM-C38-35H-R32-3700	3700	12' 1 5/8"	HEX35	C38	R32	9,5	06D-07-2897	28,7	40
MM-C38-35H-R32-4305	4305	14' 1 1/2"	HEX35	C38	R32	9,5	06D-07-0891	33,5	30
MM-C38-35H-R32-4915	4915	16' 1 1/2"	HEX35	C38	R32	9,5	06D-07-3965	38,3	30
MM-C38-35H-R32-5525	5525	18' 1 1/2"	HEX35	C38	R32	9,5	06D-07-3966	43,1	30

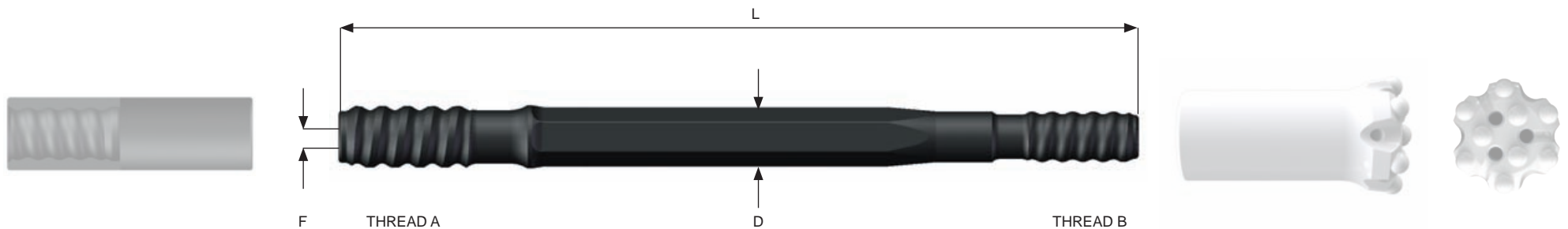

R32 DRIFTING AND TUNNELLING - COUPLINGS

1 1/4" thread Perçage de tunnels et galeries · Perforación de túneles y galerías · Проходка горных выработок

Couplings · Manchons · Coples · Муфта - R32 (1 1/4") bit thread · filetage · rosca · резьба

Order code	Length	Diameter	Thread	Bridge	Product number	Weight
Code produit	Longueur	Diamètre	Filetage	Ponté	Référence produit	Poids
Código del producto	Longitud	Diámetro	Rosca	Puente	Referencia del producto	Peso
Модель	Длина	Диаметр	Резьба	Тип соединения	Номер продукции	Вес

	L		D	Thread		Bridge	Product number	Weight
	[mm]	[ft - in]	[mm]	[A]	[B]			
Coupling Sleeve								
Coupling R38	170	6 5/8"	55	R38	R38	S	06E-07-0495	1,9
Coupling C38	190	7 1/2"	55	C38	C38	S	06E-07-0497	2,0

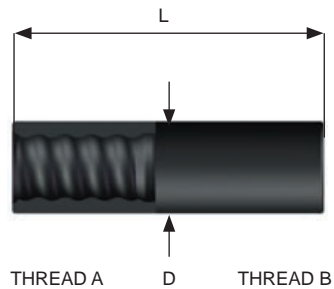

RODS - BENCH AND PRODUCTION DRILLING

R32

1 1/4" thread

Forage en gradins et production · Perforación de banco y producción
Бурение промышленных взрывных скважин на открытых и подземных горных работах

Extension Rod (Male/Female) · Tiges · Barras de extensión · Штанги - R32 (1 1/4") bit thread · filetage · rosca · резьба

Order code	Length	Diameter	Thread	Flushing	Product number	Weight	Pcs/box
Code produit	Longueur	Diamètre	Filetage	Soufflage	Référence produit	Poids	Pcs/boite
Código del producto	Longitud	Diámetro	Rosca	Orificios de barrido	Referencia del producto	Peso	Pzas./caja
Модель	Длина	Диаметр	Резьба	Промывочные отверстия	Номер продукции	Вес	Шт./упак.
	L	D		F			
	[mm] [ft - in]	[mm]	[A] [B]	[mm]		[kg]	

Extension M/F Rod R32 - round 32 - R32 - FC (Fully Carburized also suitable for underground)

MF-R32-32R-R32-0915-FC	915	3'	RND32	R32 R32	9,2	06B-07-2910	5,3	32
MF-R32-32R-R32-1220-FC	1220	4'	RND32	R32 R32	9,2	06B-07-2876	7,3	32
MF-R32-32R-R32-1525-FC	1525	5'	RND32	R32 R32	9,2	06B-07-2419	8,9	32
MF-R32-32R-R32-1830-FC	1830	6'	RND32	R32 R32	9,2	06B-07-3020	10,5	32

Extension M/F Rod R32 - round 32 - R32

MF-R32-32R-R32-3050	3050	10'	RND32	R32 R32	11,7	06B-07-2877	17,1	32
MF-R32-32R-R32-3660	3660	12'	RND32	R32 R32	11,7	06B-07-2492	20,9	32



R32 BENCH AND PRODUCTION DRILLING - RODS

1 1/4" thread

Forage en gradins et production · Perforación de banco y producción

Бурение промышленных взрывных скважин на открытых и подземных горных работах

Extension Rod (Male/Male) · Tiges · Barras de extensión · Штанги - **R32 (1 1/4") bit thread** · filetage · rosca · резьба

Order code	Length		Diameter	Thread		Flushing	Product number	Weight	Pcs/box
Code produit	Longueur		Diamètre	Filetage		Soufflage	Référence produit	Poids	Pcs/boite
Código del producto	Longitud		Diámetro	Rosca		Orificios de barrido	Referencia del producto	Peso	Pzas./caja
Модель	Длина		Диаметр	Резьба		Промывочные отверстия	Номер продукции	Вес	Шт./упак.
	L		D			F			
	[mm]	[ft - in]	[mm]	[A]	[B]	[mm]		[kg]	

Extension M/M Rod R32 - round 32 - R32 - FC (Fully Carburized also suitable for underground)

MM-R32-32R-R32-0915-FC	915	3'	RND32	R32	R32	11,7	06A-07-3247	4,6	50
MM-R32-32R-R32-1220-FC	1220	4'	RND32	R32	R32	11,7	06A-07-2899	6,3	50
MM-R32-32R-R32-1525-FC	1525	5'	RND32	R32	R32	11,7	06A-07-2900	8,0	50
MM-R32-32R-R32-1830-FC	1830	6'	RND32	R32	R32	11,7	06A-07-2901	9,7	50

Extension M/M Rod R32 - round 32 - R32

MM-R32-32R-R32-3050	3050	10'	RND32	R32	R32	11,7	06A-07-3241	16,5	50
MM-R32-32R-R32-3660	3660	12'	RND32	R32	R32	11,7	06A-07-3242	19,8	50

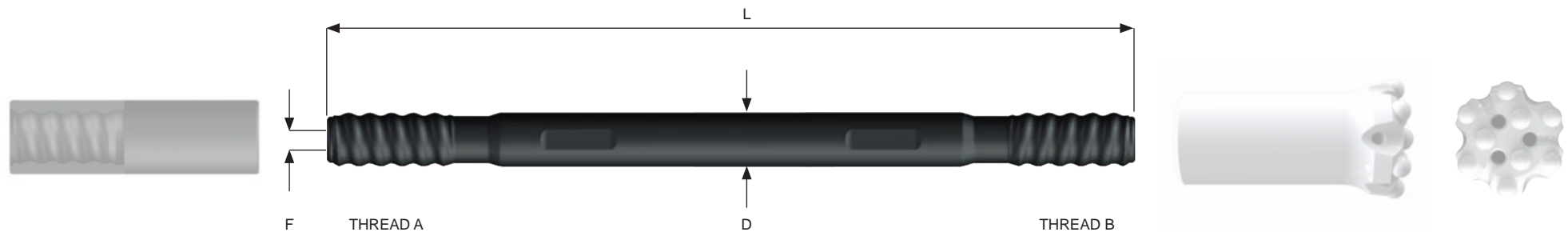

COUPLINGS - BENCH AND PRODUCTION DRILLING

R32

1 1/4" thread

Forage en gradins et production · Perforación de banco y producción
 Бурение промышленных взрывных скважин на открытых и подземных горных работах

Couplings · Manchons · Coples · Муфта - R32 (1 1/4") bit thread · filetage · rosca · резьба

Order code	Length		Diameter	Thread		Bridge	Product number	Weight
Code produit	Longueur		Diamètre	Filetage		Ponté	Référence produit	Poids
Código del producto	Longitud		Diámetro	Rosca		Puente	Referencia del producto	Peso
Модель	Длина		Диаметр	Резьба		Тип соединения	Номер продукции	Вес
	L		D					
	[mm]	[ft - in]	[mm]	[A]	[B]	[mm]		[kg]
Coupling Sleeve								
Coupling R32	150	5 7/8"	44	R32	R32	S	06E-07-0496	1,0

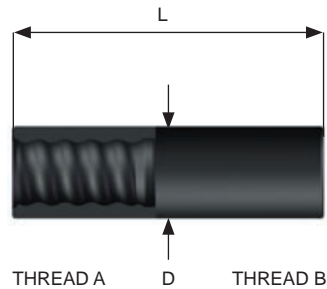

R35 DRIFTING AND TUNNELLING - BITS

1 3/8" thread

Perçage de tunnels et galeries · Perforación de túneles y galerías · Проходка горных выработок



R35 (1 3/8") · threads · filetage · rosca · резьба

Order code	Diameter		Body	Gauge	Buttons		Flushing		Product number		Weight	Pcs/box
Code produit	Diamètre		Jupe	Périphérie	Boutons		Soufflage		Référence produit		Poids	Pcs/boite
Código del producto	Diámetro		Cuerpo	Periferia	Botones		Orificios de barrido		Referencia del producto		Peso	Pzas./caja
Модель	Диаметр		Корпус	Угол	Штыри		Промывочные отверстия		Номер продукции		Вес	Шт./упак.
	[mm]	[in]		↘	[No.] [mm]	[No.] [mm]	[No.]	[No.]	[SuperDome]	[Ballistic]	[kg]	
HTG 35R48S	48	1 7/8"		35°	3 x 9	6 x 10	3	2	04-135-048-3725	04-135-048-3726	0,8	10
HTG 35R51S	51	2"		35°	3 x 9	6 x 10	3	1	04-135-051-4682	04-135-051-4683	0,9	10
HTG 35R51SR	51	2"		35°	3 x 9	6 x 10	3	1	04-135-051-4413	04-135-051-4414	1,2	10
HTG 35R54S	54	2 1/8"		35°	3 x 10	6 x 10	3	1	04-135-054-4734	04-135-054-4735	1,1	10
HTG 35R54SR	54	2 1/8"		35°	3 x 10	6 x 10	3	1	04-135-054-4131	04-135-054-4132	1,2	10



HTG 35R48S



HTG 35R51S



HTG 35R51SR



HTG 35R54S



HTG 35R54SR

RODS - DRIFTING AND TUNNELLING

R35

Perçage de tunnels et galeries · Perforación de túneles y galerías · Проходка горных выработок

1 3/8" thread

Drifter Rod · Tiges tunnels · Barras para Túneles · Перфораторная штанга - **R35 (1 3/8") bit thread** · filetage · rosca · резьба

Order code	Length		Diameter	Thread		Flushing	Product number	Weight	Pcs/box
Code produit	Longueur		Diamètre	Filetage		Soufflage	Référence produit	Poids	Pcs/boite
Código del producto	Longitud		Diámetro	Rosca		Orificios de barrido	Referencia del producto	Peso	Pzas./caja
Модель	Длина		Диаметр	Резьба		Промывочные отверстия	Номер продукции	Вес	Шт./упак.
	L		D			F			
	[mm]	[ft - in]	[mm]	[A]	[B]	[mm]		[kg]	

Drifter Rod C38 - Hex35 - R35

MM-C38-35H-R35-3090	3090	10' 1 5/8"	HEX35	C38	R35	9,5	06D-07-4348	24,1	50
MM-C38-35H-R35-3700	3700	12' 1 5/8"	HEX35	C38	R35	9,5	06D-07-4349	28,9	40
MM-C38-35H-R35-4305	4305	14' 1 1/2"	HEX35	C38	R35	9,5	06D-07-3021	33,7	30
MM-C38-35H-R35-4915	4915	16' 1 1/2"	HEX35	C38	R35	9,5	06D-07-4350	38,5	30
MM-C38-35H-R35-5525	5525	18' 1 1/2"	HEX35	C38	R35	9,5	06D-07-4057	43,3	30
MM-C38-35H-R35-6135	6135	20' 1 1/2"	HEX35	C38	R35	9,5	06D-07-6135	47,9	20
MM-C38-35H-R35-6440	6440	21'	HEX35	C38	R35	9,5	06D-07-4351	50,5	20

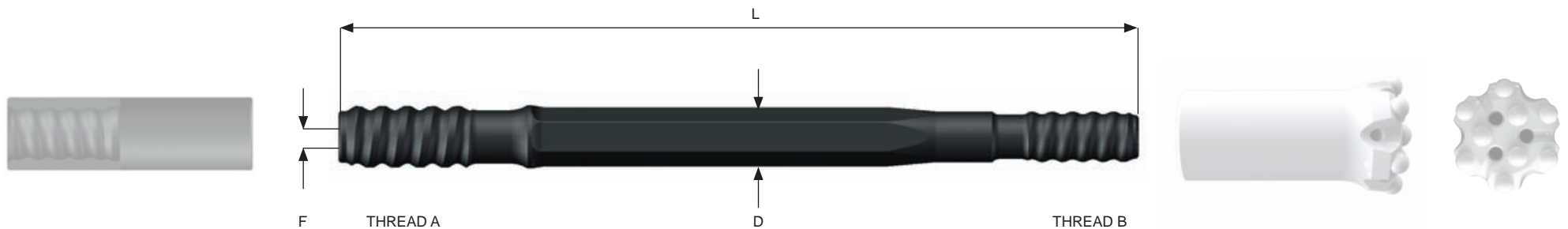

R35 DRIFTING AND TUNNELLING - RODS

1 3/8" thread

Perçage de tunnels et galeries · Perforación de túneles y galerías · Проходка горных выработок

Drifter Rod · Tiges tunnels · Barras para Túneles · Перфораторная штанга - **R35 (1 3/8") bit thread** · filetage · rosca · резьба

Order code	Length		Diameter	Thread		Flushing	Product number	Weight	Pcs/box
Code produit	Longueur		Diamètre	Filetage		Soufflage	Référence produit	Poids	Pcs/boite
Código del producto	Longitud		Diámetro	Rosca		Orificios de barrido	Referencia del producto	Peso	Pzas./caja
Модель	Длина		Диаметр	Резьба		Промывочные отверстия	Номер продукции	Вес	Шт./упак.
	L		D	F					
	[mm]	[ft - in]	[mm]	[A]	[B]	[mm]		[kg]	
Drifter Rod C38 - round 39 - R35									
MM-C38-39R-R35-4305	4305	14' 1 1/2"	RND39	C38	R35	10,3	06D-07-4352	36,9	30
MM-C38-39R-R35-4915	4915	16' 1 1/2"	RND39	C38	R35	10,3	06D-07-4353	42,2	30
MM-C38-39R-R35-5525	5525	18' 1 1/2"	RND39	C38	R35	10,3	06D-07-3974	47,5	20
MM-C38-39R-R35-6135	6135	20' 1 1/2"	RND39	C38	R35	10,3	06D-07-3975	52,8	20
MM-C38-39R-R35-6440	6440	21'	RND39	C38	R35	10,3	06D-07-3976	55,4	20

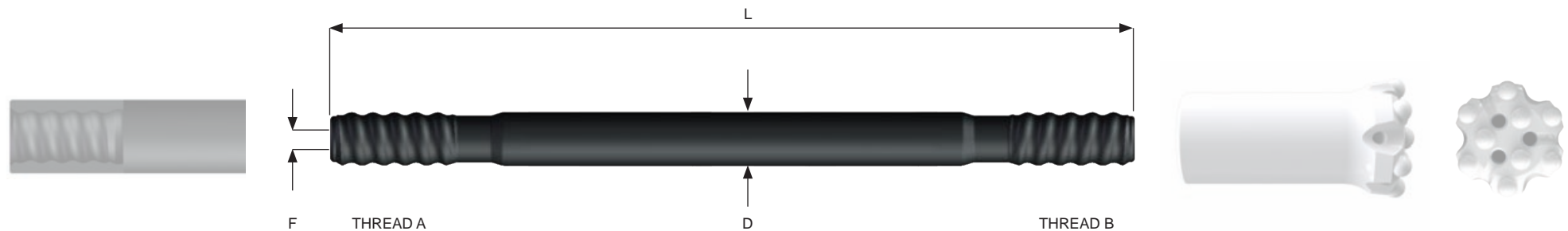

REAMING EQUIPMENT

Equipement d'alésage · Herramientas para escariar · Расширительный инструмент





REAMING EQUIPMENT

Equipement d'alésage · Herramientas para escariar · Расширительный инструмент

Pilot adapters - Chisels - Reamers - Dome reamers

Pilotes adapteurs - Burins adapteurs - Aléseurs - Aléseurs domes · Adaptadores de piloto - Adaptadores con cincel - Escariadoras - Escariadora Domo
· Адаптеры (переходники) - Долота - Расширители - Сферические расширители



Please note: Face designs might vary depending on bit diameter.

Note: Le design des têtes peut varier selon le diamètre des taillants.
Nota: Los diseños de cara pueden variar en las brocas de diámetros diferentes.
Дизайн рабочей поверхности коронки также зависит от диаметра коронки.

R32

1 1/4" thread

R35







1 3/8" thread

REAMING EQUIPMENT

Equipement d'alésage · Herramientas para escariar · Расширительный инструмент



R32 (1 1/4") & R35 (1 3/8") · threads · filetage · rosca · резьба

Order code	Buttons	Flushing	Product number	Weight
Code produit	Boutons	Soufflage	Référence produit	Poids
Código del producto	Botones	Orificios de barrido	Referencia del producto	Peso
Модель	Штыри	Промывочные отверстия	Номер продукции	Вес
			   	
	[No.]	[mm][No.]	[mm][No.][No.][SuperDome][Ballistic]	[kg]
Adapters · Pilotes adapteurs · Adaptadores de piloto · Адаптеры (переходники)				
Pilot adapter R32/R32			1 2 04-132-132-0410	- 2,4
Pilot adapter R35/R35			1 2 04-135-135-0464	- 2,4
Pilot adapter R32 Chisel			06L-24-0609-	2,5
Pilot adapter R35 Chisel			06L-24-0608-	2,5
Reamers · Aléseurs · Escariadoras · Расширители				
Reamer 89	4 x	10 8 x	12 - -04-012-089-0285	- 1,8
Reamer 102	4 x	12 8 x	12 - -04-012-102-0286	- 2,5
Reamer 127	4 x	14 8 x	14 - -04-012-127-0287	- 3,3
Reamer 140	5 x	14 10 x	14 - -04-012-140-3493	- 4,8



REAMING EQUIPMENT

Equipement d'alésage · Herramientas para escariar · Расширительный инструмент

R32

1 ¼" thread

C38







1 ½" thread

C45

1 ¾" thread

Reaming Equipment

R32 (1 ¼"), C38 (1 ⅜") & C45 (1 ¾") · threads · filetage · rosca · резьба

Order code Code produit Código del producto Модель	Diameter Diamètre Diámetro Диаметр	Buttons Boutons Botones Штыри	Flushing Soufflage Orificios de barrido Промывочные отверстия	Product number Référence produit Referencia del producto Номер продукции	Weight Poids Peso Вес	
	D [mm] [in]	 [No.] [mm]	 [No.] [mm]	 [No.]  [No.]	 [SuperDome]  [Ballistic]	[kg]

Dome reamers · Aléseurs domes · Escariadora Domo · Сферические расширители

HTG 32R89 Dome	40	1 5/8"	4 x 9	12 x 12	2	2	04-132-089-2265	04-132-089-2266	2,5
HTG 32R102 Dome	40	1 5/8"	4 x 9	14 x 12	2	2	04-132-102-2268	04-132-102-2269	3,2
HTG 32R127 Dome	40	1 5/8"	4 x 9	18 x 14	2	2	04-132-127-2938	04-132-127-3393	5,8
HTG 38C89 Dome	58	2 ¼"	5 x 12	12 x 12	2	2	01-238-089-2979	-	3,4
HTG 38C102 Dome	52	2"	5 x 10	12 x 12	2	2	01-238-102-3520	-	4,5
HTG 38C127 Dome	58	2 ¼"	5 x 12	18 x 14	2	2	01-238-127-3946	-	6,4
HTG 38C153 Dome	84	3 ⅓"	5 x 14	21 x 14	4	2	01-238-153-3476	-	10,7
HTG 45C180 Dome	73	2 7/8"	4 x 14	21 x 16	4	2	01-245-180-5212	-	17,9
HTG 45C220 Dome	100	4"	5 x 14	24 x 16	4	2	01-245-220-4250	-	29,0

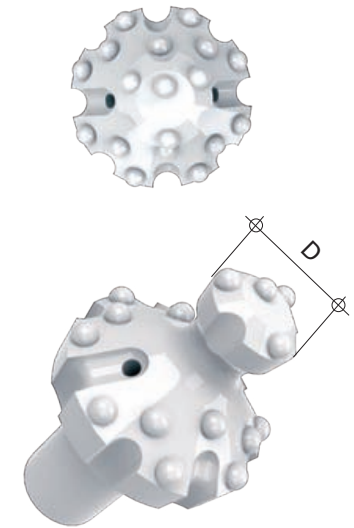

BENCH AND PRODUCTION DRILLING

Forage en gradins et production · Perforación de banco y producción

Бурение промышленных взрывных скважин на открытых и подземных горных работах





BENCH AND PRODUCTION DRILLING

Forage en gradins et production · Perforación de banco y producción

Бурение промышленных взрывных скважин на открытых и подземных горных работах

Bench Drilling - Long-hole Drilling - Precision Drilling

Forage en gradins - Forage profond - Forage de précision · Perforación de Banco - Perforación de barrenos largos - Perforación precisa

Бурение на открытых выработках - Бурение глубоких скважин - Направленное бурение



B, BR

HARD + ABRASIVE ROCK MODEL

Modèle pour roche dure et abrasive
Modelo para roca dura y abrasiva

Модель для крепких и абразивных горных пород

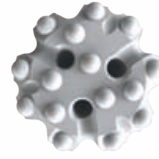

A, AR

MEDIUM AND HARD ROCK MODEL

Modèle pour roche medium et dure
Modelo para roca dura y media dura

Модель для средних и крепких пород



DS, DSR

DROP CENTER MODEL FOR STRAIGHTER HOLES

Modèle drop center pour plus de rectitude du forage
Centro deprimido para perforaciones más rectas

Модели с утопленным центром для уменьшения отклонения бурового става при бурении скважин

Please note: Face designs might vary depending on bit diameter.

Note: Le design des têtes peut varier selon le diamètre des taillants.

Nota: Los diseños de cara pueden variar dependiendo del diámetro de la broca.
Дизайн рабочей поверхности коронки также зависит от диаметра коронки.



Bench and
Production Drilling

C38 BENCH AND PRODUCTION DRILLING - BITS

1 1/2" thread

Forage en gradins et production · Perforación de banco y producción

Бурение промышленных взрывных скважин на открытых и подземных горных работах



C38 (1 1/2") · threads · filetage · rosca · резьба

Order code	Diameter		Body	Gauge	Buttons		Flushing		Product number		Weight	Pcs/box		
Code produit	Diamètre		Jupe	Périphérie	Boutons		Soufflage		Référence produit		Poids	Pcs/boite		
Código del producto	Diámetro		Cuerpo	Periferia	Botones		Orificios de barrido		Referencia del producto		Peso	Pzas./caja		
Модель	Диаметр		Корпус	Угол	Штыри		Промывочные отверстия		Номер продукции		Вес	Шт./упак.		
	[mm]	[in]		↘	 [No.]	 [mm]	 [No.]	 [mm]	 [No.]	 [No.]	 [SuperDome]	 [Ballistic]	[kg]	
HTG 38C55S	55	2 1/8"		35°	3 x 10	6 x 11	3	1	01-238-055-5604	01-238-055-5605	0,9	10		
HTG 38C60DS	60	2 3/8"		35°	4 x 10	6 x 10	3	-	01-238-060-4063	01-238-060-4064	1,5	5		
HTG 38C60DSR	60	2 3/8"		35°	4 x 10	6 x 10	3	-	01-238-060-3750	01-238-060-3751	1,4	5		
HTG 38C64A	64	2 1/2"		35°	4 x 10	8 x 10	2	-	01-238-064-2244	01-238-064-2245	1,6	5		
HTG 38C64DS	64	2 1/2"		35°	5 x 9	8 x 10	4	-	01-238-064-4060	01-238-064-4061	1,6	5		
HTG 38C64AR	64	2 1/2"		35°	4 x 10	8 x 10	2	-	01-238-064-1034	01-238-064-1038	1,8	5		
HTG 38C64DSR	64	2 1/2"		35°	5 x 9	8 x 10	4	-	01-238-064-2386	01-238-064-2387	1,8	5		
HTG 38C70DS	70	2 3/4"		35°	5 x 10	8 x 10	4	-	01-238-070-4069	01-238-070-4070	1,7	4		
HTG 38C70DSR	70	2 3/4"		35°	5 x 10	8 x 10	4	-	01-238-070-3690	01-238-070-3691	2,5	4		



HTG 38C55S



HTG 38C60DSR



HTG 38C64A



HTG 38C64DS



HTG 38C64AR



HTG 38C64DSR



HTG 38C70DS



HTG 38C70DSR

BITS - BENCH AND PRODUCTION DRILLING



C38

Forage en gradins et production · Perforación de banco y producción

1 1/2" thread

Бурение промышленных взрывных скважин на открытых и подземных горных работах

C38 (1 1/2") · threads · filetage · rosca · резьба

Order code	Diameter		Body	Gauge	Buttons		Flushing		Product number		Weight	Pcs/box		
Code produit	Diamètre		Jupe	Périphérie	Boutons		Soufflage		Référence produit		Poids	Pcs/boite		
Código del producto	Diámetro		Cuerpo	Periferia	Botones		Orificios de barrido		Referencia del producto		Peso	Pzas./caja		
Модель	Диаметр		Корпус	Угол	Штыри		Промывочные отверстия		Номер продукции		Вес	Шт./упак.		
	[mm]	[in]		°	[No.]	[mm]	[No.]	[mm]	[No.]	[No.]	[SuperDome]	[Ballistic]	[kg]	
HTG 38C76A	76	3"		35°	5 x 10	9 x 10	3	-	01-238-076-2048	01-238-076-2049	2,1	4		
HTG 38C76B	76	3"		35°	4 x 12	8 x 13	2	-	01-238-076-1077	01-238-076-1080	2,1	4		
HTG 38C76DS	76	3"		35°	5 x 11	8 x 11	4	-	01-238-076-4066	01-238-076-4067	2,2	4		
HTG 38C76AR	76	3"		35°	5 x 10	9 x 10	3	-	01-238-076-2157	01-238-076-2158	3,1	4		
HTG 38C76DSR	76	3"		35°	5 x 11	8 x 11	4	-	01-238-076-3952	01-238-076-3953	3,1	4		
HTG 38C89A	89	3 1/2"		35°	6 x 12	9 x 12	3	-	01-238-089-2192	01-238-089-2193	2,7	2		
HTG 38C89DS	89	3 1/2"		35°	5 x 12	8 x 12	4	-	01-238-089-4272	01-238-089-4273	2,8	2		
HTG 38C89DSR	89	3 1/2"		35°	5 x 12	8 x 12	4	-	01-238-089-4344	01-238-089-4345	4,1	2		



HTG 38C76A



HTG 38C76B



HTG 38C76DS



HTG 38C76AR



HTG 38C76DSR



HTG 38C89A



HTG 38C89DS



HTG 38C89DSR

Bench and Production Drilling

C38 BENCH AND PRODUCTION DRILLING - RODS

1 1/2" thread

Forage en gradins et production · Perforación de banco y producción

Бурение промышленных взрывных скважин на открытых и подземных горных работах

Extension Rod (Male/Female) · Tiges · Barras de extensión · Штанги - **C38 (1 1/2") bit thread** · filetage · rosca · резьба

Order code	Length	Diameter	Thread	Flushing	Product number	Weight	Pcs/box
Code produit	Longueur	Diamètre	Filetage	Soufflage	Référence produit	Poids	Pcs/boite
Código del producto	Longitud	Diámetro	Rosca	Orificios de barrido	Referencia del producto	Peso	Pzas./caja
Модель	Длина	Диаметр	Резьба	Промывочные отверстия	Номер продукции	Вес	Шт./упак.
	L	D	F				
	[mm] [ft - in]	[mm]	[A]	[B]	[mm]	[kg]	

Extension M/F Rod C38 - round 39 - C38 - FC (Fully Carburized also suitable for underground)

MF-C38-39R-C38-1220-FC	1220	4'	RND39	C38	C38	14,5	06B-07-2911	10,6	32
MF-C38-39R-C38-1525-FC	1525	5'	RND39	C38	C38	14,5	06B-07-2420	13,1	24
MF-C38-39R-C38-1830-FC	1830	6'	RND39	C38	C38	14,5	06B-07-2879	15,6	24

Extension M/F Rod C38 - round 39 - C38

MF-C38-39R-C38-3050	3050	10'	RND39	C38	C38	14,5	06B-07-2199	25,6	24
MF-C38-39R-C38-3660	3660	12'	RND39	C38	C38	14,5	06B-07-2491	30,4	24
MF-C38-39R-C38-4265	4265	14'	RND39	C38	C38	14,5	06B-07-3243	35,2	24



RODS - BENCH AND PRODUCTION DRILLING

C38

Forage en gradins et production · Perforación de banco y producción
 Бурение промышленных взрывных скважин на открытых и подземных горных работах

1 1/2" thread

Extension Rod (Male/Male) · Tiges · Barras de extensión · Штанги - C38 (1 1/2") bit thread · filetage · rosca · резьба

Order code	Length	Diameter	Thread	Flushing	Product number	Weight	Pcs/box
Code produit	Longueur	Diamètre	Filetage	Soufflage	Référence produit	Poids	Pcs/boite
Código del producto	Longitud	Diámetro	Rosca	Orificios de barrido	Referencia del producto	Peso	Pzas./caja
Модель	Длина	Диаметр	Резьба	Промывочные отверстия	Номер продукции	Вес	Шт./упак.
L	D	F	[A] [B]		[mm]	[kg]	
[mm] [ft - in]	[mm]	[mm]			[mm]		

Extension M/M Rod C38 - round 39 - C38

MM-C38-39R-C38-3050	3050	10'	RND39	C38	C38	14,5	06A-07-0492	24,3	50
MM-C38-39R-C38-3660	3660	12'	RND39	C38	C38	14,5	06A-07-0491	29,2	40

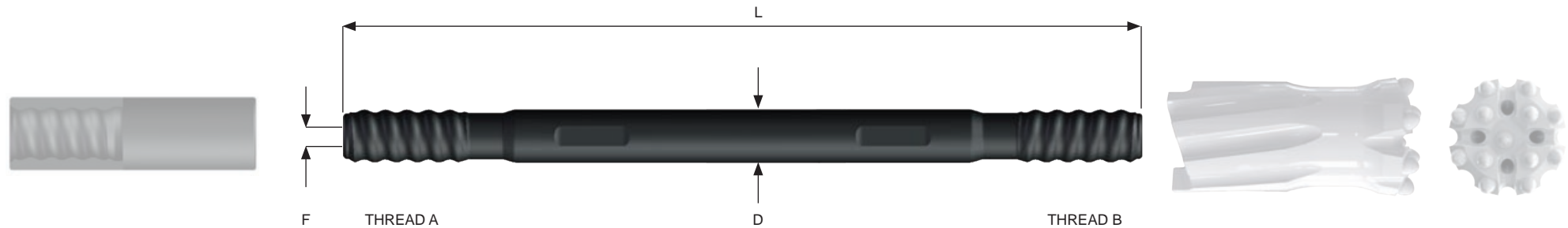

Bench and
Production Drilling

C38 BENCH AND PRODUCTION DRILLING - COUPLINGS

1 1/2" thread

Forage en gradins et production · Perforación de banco y producción

Бурение промышленных взрывных скважин на открытых и подземных горных работах

Couplings · Manchons · Coples · Муфта - **C38 (1 1/2") bit thread** · filetage · rosca · резьба

Order code	Length	Diameter	Thread	Bridge	Product number	Weight
Code produit	Longueur	Diamètre	Filetage	Ponté	Référence produit	Poids
Código del producto	Longitud	Diámetro	Rosca	Puente	Referencia del producto	Peso
Модель	Длина	Диаметр	Резьба	Тип соединения	Номер продукции	Вес

	L		D	Thread		Bridge	Product number	Weight
	[mm]	[ft - in]	[mm]	[A]	[B]			
Coupling Sleeve								
Coupling C38	190	7 1/2"	55	C38	C38	S	06E-07-0497	2,0

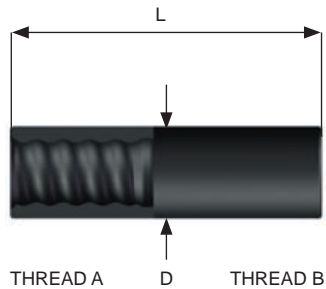

BITS - BENCH AND PRODUCTION DRILLING



C45

Forage en gradins et production · Perforación de banco y producción

1 3/4" thread

Бурение промышленных взрывных скважин на открытых и подземных горных работах

C45 (1 3/4") · threads · filetage · rosca · резьба

Order code	Diameter		Body	Gauge	Buttons		Flushing		Product number		Weight	Pcs/box		
Code produit	Diamètre		Juqe	Périphérie	Boutons		Soufflage		Référence produit		Poids	Pcs/boite		
Código del producto	Diámetro		Cuerpo	Periferia	Botones		Orificios de barrido		Referencia del producto		Peso	Pzas./caja		
Модель	Диаметр		Корпус	Угол	Штыри		Промывочные отверстия		Номер продукции		Вес	Шт./упак.		
	[mm]	[in]		↘	[No.]	[mm]	[No.]	[mm]	[No.]	[No.]	[SuperDome]	[Ballistic]	[kg]	
HTG 45C70DS	70	2 3/4"		35°	5 x 10	8 x 10	4	-	01-245-070-4035	01-245-070-4036	2,1	4		
HTG 45C70DSR	70	2 3/4"		35°	5 x 10	8 x 10	4	-	01-245-070-3695	01-245-070-3696	2,4	4		
HTG 45C76A	76	3"		35°	5 x 10	9 x 10	3	-	01-245-076-2350	01-245-076-2351	2,4	4		
HTG 45C76B	76	3"		35°	4 x 12	8 x 13	2	-	01-245-076-2081	01-245-076-2082	2,4	4		
HTG 45C76DS	76	3"		35°	5 x 11	8 x 11	4	-	01-245-076-4072	01-245-076-4073	2,3	4		
HTG 45C76AR	76	3"		35°	5 x 10	9 x 10	3	-	01-245-076-2168	01-245-076-2169	2,7	4		
HTG 45C76DSR	76	3"		35°	5 x 11	8 x 11	4	-	01-245-076-3720	01-245-076-3721	2,9	4		
HTG 45C83DS	83	3 1/4"		35°	5 x 12	8 x 12	4	-	01-245-083-4075	01-245-083-4076	2,8	2		



HTG 45C70DS



HTG 45C70DSR



HTG 45C76A



HTG 45C76B



HTG 45C76DS



HTG 45C76AR



HTG 45C76DSR



HTG 45C83DS

Bench and Production Drilling

C45 BENCH AND PRODUCTION DRILLING - BITS

1 3/4" thread

Forage en gradins et production · Perforación de banco y producción

Бурение промышленных взрывных скважин на открытых и подземных горных работах



C45 (1 3/4") · threads · filetage · rosca · резьба

Order code	Diameter		Body	Gauge	Buttons		Flushing		Product number		Weight	Pcs/box		
Code produit	Diamètre		Jupe	Périphérie	Boutons		Soufflage		Référence produit		Poids	Pcs/boite		
Código del producto	Diámetro		Cuerpo	Periferia	Botones		Orificios de barrido		Referencia del producto		Peso	Pzas./caja		
Модель	Диаметр		Корпус	Угол	Штыри		Промывочные отверстия		Номер продукции		Вес	Шт./упак.		
	[mm]	[in]		↘	 [No.]	 [mm]	 [No.]	 [mm]	 [No.]	 [No.]	 [SuperDome]	 [Ballistic]	[kg]	
HTG 45C83DSR	83	3 1/4"		35°	5 x 12	8 x 12	4	-	01-245-083-3733	01-245-083-3734	3,5	2		
HTG 45C89A	89	3 1/2"		35°	6 x 12	9 x 12	3	-	01-245-089-1169	01-245-089-1172	3,2	2		
HTG 45C89B	89	3 1/2"		35°	4 x 14	8 x 14	2	-	01-245-089-1182	01-245-089-1184	3,3	2		
HTG 45C89DS	89	3 1/2"		35°	5 x 12	8 x 12	4	-	01-245-089-4081	01-245-089-4082	3,2	2		
HTG 45C89AR	89	3 1/2"		35°	6 x 12	9 x 12	3	-	01-245-089-1176	01-245-089-1180	4,5	2		
HTG 45C89DSR	89	3 1/2"		35°	5 x 12	8 x 12	4	-	01-245-089-3742	01-245-089-3743	4,4	2		
HTG 45C102DS	102	4"		35°	7 x 12	9 x 14	3	-	01-245-102-2555	01-245-102-3058	4,2	2		
HTG 45C102DSR	102	4"		35°	7 x 12	9 x 14	3	-	01-245-102-2210	01-245-102-2211	6,3	2		



HTG 45C83DSR



HTG 45C89A



HTG 45C89B



HTG 45C89DS



HTG 45C89AR



HTG 45C89DSR



HTG 45C102DS



HTG 45C102DSR

RODS - BENCH AND PRODUCTION DRILLING

C45

Forage en gradins et production · Perforación de banco y producción
 Бурение промышленных взрывных скважин на открытых и подземных горных работах

1 3/4" thread

Extension Rod (Male/Female) · Tiges · Barras de extensión · Штанги - C45 (1 3/4") bit thread · filetage · rosca · резьба

Order code	Length	Diameter	Thread	Flushing	Product number	Weight	Pcs/box
Code produit	Longueur	Diamètre	Filetage	Soufflage	Référence produit	Poids	Pcs/boite
Código del producto	Longitud	Diámetro	Rosca	Orificios de barrido	Referencia del producto	Peso	Pzas./caja
Модель	Длина	Диаметр	Резьба	Промывочные отверстия	Номер продукции	Вес	Шт./упак.
	L	D		F			
	[mm] [ft - in]	[mm]	[A] [B]	[mm]		[kg]	

Extension M/F Rod C45 - round 46 - C45 - FC (Fully Carburized also suitable for underground)

MF-C45-46R-C45-1525-FC	1525	5'	RND46	C45 C45	17,0	06B-07-2421	18,2	24
MF-C45-46R-C45-1830-FC	1830	6'	RND46	C45 C45	17,0	06B-07-3019	21,5	24

Extension M/F Rod C45 - round 46 - C45

MF-C45-46R-C45-3050	3050	10'	RND46	C45 C45	17,0	06B-07-2882	35,7	24
MF-C45-46R-C45-3660	3660	12'	RND46	C45 C45	17,0	06B-07-0501	42,5	24
MF-C45-46R-C45-4265	4265	14'	RND46	C45 C45	17,0	06B-07-2912	49,5	24
MF-C45-46R-C45-6095	6095	20'	RND46	C45 C45	17,0	06B-07-3244	69,0	16



C45 BENCH AND PRODUCTION DRILLING - RODS

1 3/4" thread

Forage en gradins et production · Perforación de banco y producción

Бурение промышленных взрывных скважин на открытых и подземных горных работах

Extension Rod (Male/Male) · Tiges · Barras de extensión · Штанги - **C45 (1 3/4") bit thread** · filetage · rosca · резьба

Order code	Length	Diameter	Thread	Flushing	Product number	Weight	Pcs/box
Code produit	Longueur	Diamètre	Filetage	Soufflage	Référence produit	Poids	Pcs/boite
Código del producto	Longitud	Diámetro	Rosca	Orificios de barrido	Referencia del producto	Peso	Pzas./caja
Модель	Длина	Диаметр	Резьба	Промывочные отверстия	Номер продукции	Вес	Шт./упак.
	L	D	F				
	[mm] [ft - in]	[mm]	[A]	[B]	[mm]	[kg]	

Extension M/M Rod C45 - round 46 - C45

MM-C45-46R-C45-3050	3050	10'	RND46	C45	C45	17,0	06A-07-0489	33,6	30
MM-C45-46R-C45-3660	3660	12'	RND46	C45	C45	17,0	06A-07-2905	40,4	30
MM-C45-46R-C45-4265	4265	14'	RND46	C45	C45	17,0	06A-07-2906	47,1	25

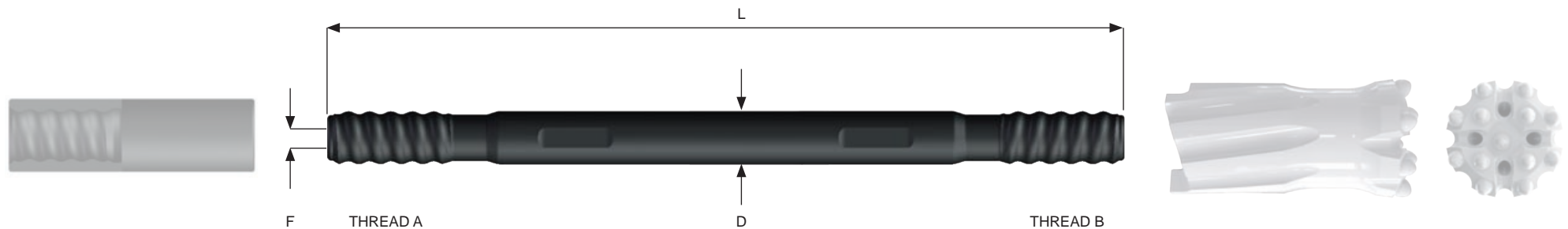

COUPLINGS - BENCH AND PRODUCTION DRILLING

C45

1 3/4" thread

Forage en gradins et production · Perforación de banco y producción
 Бурение промышленных взрывных скважин на открытых и подземных горных работах

Couplings · Manchons · Coples · Муфта - **C45 (1 3/4") bit thread** · filetage · rosca · резьба

Order code	Length		Diameter	Thread		Bridge	Product number	Weight
Code produit	Longueur		Diamètre	Filetage		Ponté	Référence produit	Poids
Código del producto	Longitud		Diámetro	Rosca		Puente	Referencia del producto	Peso
Модель	Длина		Диаметр	Резьба		Тип соединения	Номер продукции	Вес
	L		D					
	[mm]	[ft - in]	[mm]	[A]	[B]	[mm]		[kg]
Coupling Sleeve								
Coupling C45	210	8 1/4"	63	C45	C45	S	06E-07-0889	2,8

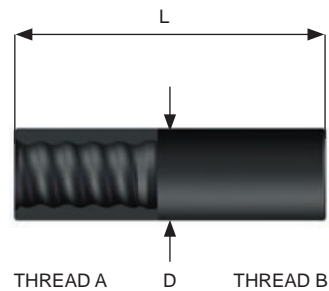

Bench and
Production Drilling

C51 BENCH AND PRODUCTION DRILLING - BITS

2" thread

Forage en gradins et production · Perforación de banco y producción

Бурение промышленных взрывных скважин на открытых и подземных горных работах



C51 (2") · threads · filetage · rosca · резьба

Order code	Diameter		Body	Gauge	Buttons		Flushing		Product number		Weight	Pcs/box
Code produit	Diamètre		Jupe	Périphérie	Boutons		Soufflage		Référence produit		Poids	Pcs/boite
Código del producto	Diámetro		Cuerpo	Periferia	Botones		Orificios de barrido		Referencia del producto		Peso	Pzas./caja
Модель	Диаметр		Корпус	Угол	Штыри		Промывочные отверстия		Номер продукции		Вес	Шт./упак.
	[mm]	[in]									[kg]	
				°	[No.] [mm]	[No.] [mm]	[No.]	[No.]	[SuperDome]	[Ballistic]		
HTG 51C83DS	83	3¼"		35°	5 x 12	8 x 12	4	-	01-251-083-4084	01-251-083-4085	3,0	2
HTG 51C83DSR	83	3¼"		35°	5 x 12	8 x 12	4	-	01-251-083-3739	01-251-083-3740	3,2	2
HTG 51C89A	89	3½"		35°	6 x 12	9 x 12	3	-	01-251-089-2104	01-251-089-2105	3,4	2
HTG 51C89B	89	3½"		35°	4 x 14	8 x 14	2	-	01-251-089-1247	01-251-089-1249	3,6	2
HTG 51C89DS	89	3½"		35°	5 x 12	8 x 12	4	-	01-251-089-4038	01-251-089-4039	3,4	2
HTG 51C89AR	89	3½"		35°	6 x 12	9 x 12	3	-	01-251-089-1240	01-251-089-1243	4,1	2
HTG 51C89BR	89	3½"		35°	4 x 14	8 x 14	2	-	01-251-089-1251	01-251-089-1253	4,5	2
HTG 51C89DSR	89	3½"		35°	5 x 12	8 x 12	4	-	01-251-089-3745	01-251-089-3746	4,0	2



HTG 51C83DS



HTG 51C83DSR



HTG 51C89A



HTG 51C89B



HTG 51C89DS



HTG 51C89AR



HTG 51C89BR



HTG 51C89DSR

BITS - BENCH AND PRODUCTION DRILLING





C51

Forage en gradins et production · Perforación de banco y producción

2" thread

Бурение промышленных взрывных скважин на открытых и подземных горных работах

C51 (2") · threads · filetage · rosca · резьба

Order code	Diameter		Body	Gauge	Buttons		Flushing		Product number		Weight	Pcs/box		
Code produit	Diamètre		Jupe	Périphérie	Boutons		Soufflage		Référence produit		Poids	Pcs/boite		
Código del producto	Diámetro		Cuerpo	Periferia	Botones		Orificios de barrido		Referencia del producto		Peso	Pzas./caja		
Модель	Диаметр		Корпус	Угол	Штыри		Промывочные отверстия		Номер продукции		Вес	Шт./упак.		
	[mm]	[in]		°	[No.]	[mm]	[No.]	[mm]	[No.]	[No.]	[SuperDome]	[Ballistic]	[kg]	
HTG 51C102A	102	4"		35°	6 x 13	9 x 13	3	-	01-251-102-2063	01-251-102-2064	4,7	1		
HTG 51C102DS	102	4"		35°	7 x 12	9 x 14	3	-	01-251-102-2060	01-251-102-2061	4,7	1		
HTG 51C102AR	102	4"		35°	6 x 13	9 x 13	3	-	01-251-102-2559	01-251-102-2732	6,5	1		
HTG 51C102DSR	102	4"		35°	7 x 12	9 x 14	3	-	01-251-102-1284	01-251-102-1287	6,5	1		
HTG 51C115A	115	4½"		35°	7 x 14	10 x 14	3	-	01-251-115-2110	01-251-115-2111	6,0	1		
HTG 51C115DS	115	4½"		35°	7 x 14	10 x 14	3	-	01-251-115-2160	01-251-115-2161	6,0	1		
HTG 51C115AR	115	4½"		35°	7 x 14	10 x 14	3	-	01-251-115-2346	01-251-115-2347	9,1	1		
HTG 51C115DSR	115	4½"		35°	7 x 14	10 x 14	3	-	01-251-115-2066	01-251-115-2067	9,1	1		



HTG 51C102A



HTG 51C102DS



HTG 51C102AR



HTG 51C102DSR



HTG 51C115A



HTG 51C115DS



HTG 51C115AR



HTG 51C115DSR

Bench and Production Drilling

C51 BENCH AND PRODUCTION DRILLING - BITS

2" thread

Forage en gradins et production · Perforación de banco y producción

Бурение промышленных взрывных скважин на открытых и подземных горных работах



C51 (2") · threads · filetage · rosca · резьба

Order code	Diameter		Body	Gauge	Buttons		Flushing		Product number		Weight	Pcs/box
Code produit	Diamètre		Jupe	Périphérie	Boutons		Soufflage		Référence produit		Poids	Pcs/boite
Código del producto	Diámetro		Cuerpo	Periferia	Botones		Orificios de barrido		Referencia del producto		Peso	Pzas./caja
Модель	Диаметр		Корпус	Угол	Штыри		Промывочные отверстия		Номер продукции		Вес	Шт./упак.
	[mm]	[in]									[kg]	
				°	[No.] [mm]	[No.] [mm]	[No.]	[No.]	[SuperDome]	[Ballistic]		
HTG 51C127A	127	5"		35°	8 x 14	10 x 14	3	-	01-251-127-2313	01-251-127-2314	8,3	1
HTG 51C127DS	127	5"		35°	6 x 16	10 x 16	5	-	01-251-127-2069	01-251-127-2070	8,3	1
HTG 51C127DSR	127	5"		35°	6 x 16	10 x 16	5	-	01-251-127-2072	01-251-127-2073	11,1	1



HTG 51C127A



HTG 51C127DS



HTG 51C127DSR

RODS - BENCH AND PRODUCTION DRILLING

C51

2" thread

Forage en gradins et production · Perforación de banco y producción
Бурение промышленных взрывных скважин на открытых и подземных горных работах

Extension Rod (Male/Female) · Tiges · Barras de extensión · Штанги - C51 (2") bit thread · filetage · rosca · резьба

Order code	Length		Diameter	Thread		Flushing	Product number	Weight	Pcs/box
Code produit	Longueur		Diamètre	Filetage		Soufflage	Référence produit	Poids	Pcs/boite
Código del producto	Longitud		Diámetro	Rosca		Orificios de barrido	Referencia del producto	Peso	Pzas./caja
Модель	Длина		Диаметр	Резьба		Промывочные отверстия	Номер продукции	Вес	Шт./упак.
	L		D			F			
	[mm]	[ft - in]	[mm]	[A]	[B]	[mm]		[kg]	

Extension M/F Rod C51 - round 52 - C51 - FC (Fully Carburized also suitable for underground)

MF-C51-52R-C51-1525-FC	1525	5'	RND52	C51	C51	21,5	06B-07-3248	23,3	18
MF-C51-52R-C51-1830-FC	1830	6'	RND52	C51	C51	21,5	06B-07-2883	27,3	18

Extension M/F Rod C51 - round 52 - C51

MF-C51-52R-C51-3660	3660	12'	RND52	C51	C51	21,5	06B-07-0500	52,5	18
MF-C51-52R-C51-4265	4265	14'	RND52	C51	C51	21,5	06B-07-2884	61,0	18
MF-C51-52R-C51-6095	6095	20'	RND52	C51	C51	21,5	06B-07-3245	85,6	12



C51 BENCH AND PRODUCTION DRILLING - RODS

2" thread

Forage en gradins et production · Perforación de banco y producción

Бурение промышленных взрывных скважин на открытых и подземных горных работах

Extension Rod (Male/Male) · Tiges · Barras de extensión · Штанги - **C51 (2") bit thread** · filetage · rosca · резьба

Order code	Length	Diameter	Thread	Flushing	Product number	Weight	Pcs/box
Code produit	Longueur	Diamètre	Filetage	Soufflage	Référence produit	Poids	Pcs/boite
Código del producto	Longitud	Diámetro	Rosca	Orificios de barrido	Referencia del producto	Peso	Pzas./caja
Модель	Длина	Диаметр	Резьба	Промывочные отверстия	Номер продукции	Вес	Шт./упак.
	L	D	F				
	[mm] [ft - in]	[mm]	[A]	[B]	[mm]	[kg]	

Extension M/M Rod C51 - round 52 - C51

MM-C51-52R-C51-3660	3660	12'	RND52	C51	C51	21,5	06A-07-2536	49,8	25
MM-C51-52R-C51-4265	4265	14'	RND52	C51	C51	21,5	06A-07-2909	58,1	20
MM-C51-52R-C51-6095	6095	20'	RND52	C51	C51	21,5	06A-07-3246	83,5	15

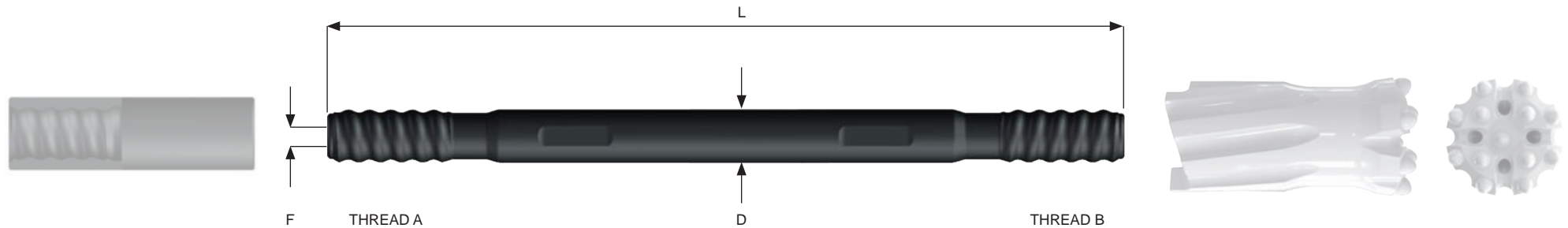

COUPLINGS - BENCH AND PRODUCTION DRILLING

C51

2" thread

Forage en gradins et production · Perforación de banco y producción
 Бурение промышленных взрывных скважин на открытых и подземных горных работах

Couplings · Manchons · Coples · Муфта - C51 (2") bit thread · filetage · rosca · резьба

Order code	Length		Diameter	Thread		Bridge	Product number	Weight
Code produit	Longueur		Diamètre	Filetage		Ponté	Référence produit	Poids
Código del producto	Longitud		Diámetro	Rosca		Puente	Referencia del producto	Peso
Модель	Длина		Диаметр	Резьба		Тип соединения	Номер продукции	Вес
	L		D	[A] [B]		[mm]		[kg]
	[mm]	[ft - in]	[mm]					
Coupling Sleeve								
Coupling C51-D72	225	8 ⁷ / ₈ "	72	C51	C51	S	06E-07-2853	3,8
Coupling C51-D77	225	8 ⁷ / ₈ "	77	C51	C51	S	06E-07-0494	4,7

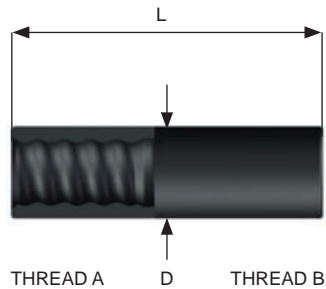

Bench and Production Drilling

C58 BENCH AND PRODUCTION DRILLING - BITS











2 1/4" thread

Forage en gradins et production · Perforación de banco y producción

Бурение промышленных взрывных скважин на открытых и подземных горных работах



C58 (2 1/4") · threads · filetage · rosca · резьба

Order code	Diameter		Body	Gauge	Buttons		Flushing		Product number		Weight	Pcs/box
Code produit	Diamètre		Jupe	Périphérie	Boutons		Soufflage		Référence produit		Poids	Pcs/boite
Código del producto	Diámetro		Cuerpo	Periferia	Botones		Orificios de barrido		Referencia del producto		Peso	Pzas./caja
Модель	Диаметр		Корпус	Угол	Штыри		Промывочные отверстия		Номер продукции		Вес	Шт./упак.
	[mm]	[in]		↘	[No.] 	[mm] [No.] 	[No.] 	[No.] 			[kg]	
HTG 58C92DSR	92	3 5/8"		35°	5 x 13	8 x 13	4	-	01-358-092-4332	01-358-092-4333	5,2	2
HTG 58C102DSR	102	4"		35°	7 x 12	9 x 14	3	-	01-358-102-2495	01-358-102-2496	6,6	1
HTG 58C115DSR	115	4 1/2"		35°	7 x 14	10 x 14	3	-	01-358-115-2560	01-358-115-3394	9,6	1
HTG 58C127DSR	127	5"		35°	6 x 16	10 x 16	5	-	01-358-127-2561	01-358-127-2734	12,3	1



HTG 58C92DSR



HTG 58C102DSR



HTG 58C115DSR



HTG 58C127DSR

BITS - BENCH AND PRODUCTION DRILLING RG60

Forage en gradins et production · Perforación de banco y producción 2 1/3" thread
 Бурение промышленных взрывных скважин на открытых и подземных горных работах

RG60 (2 1/3") · threads · filetage · rosca · резьба

Order code	Diameter		Body	Gauge	Buttons		Flushing		Product number		Weight	Pcs/box
Code produit	Diamètre		Jupe	Périphérie	Boutons		Soufflage		Référence produit		Poids	Pcs/boite
Código del producto	Diámetro		Cuerpo	Periferia	Botones		Orificios de barrido		Referencia del producto		Peso	Pzas./caja
Модель	Диаметр		Корпус	Угол	Штыри		Промывочные отверстия		Номер продукции		Вес	Шт./упак.
	[mm]	[in]		↘	[No.] [mm]	[No.] [mm]	[No.]	[No.]	[SuperDome]	[Ballistic]	[kg]	
HTG 60RG95AR	95	3 3/4"		35°	6 x 12	9 x 12	3	-	01-460-095-1375	01-460-095-1376	6,5	2
HTG 60RG102A	102	4"		35°	6 x 13	9 x 13	3	-	01-460-102-2562	01-460-102-3395	5,7	1
HTG 60RG102DS	102	4"		35°	7 x 12	9 x 14	3	-	01-460-102-2563	01-460-102-3396	5,7	1
HTG 60RG102AR	102	4"		35°	6 x 13	9 x 13	3	-	01-460-102-2204	01-460-102-2205	7,4	1
HTG 60RG102DSR	102	4"		35°	7 x 12	9 x 14	3	-	01-460-102-2253	01-460-102-2254	7,4	1
HTG 60RG115A	115	4 1/2"		35°	7 x 14	10 x 14	3	-	01-460-115-2564	01-460-115-3397	7,5	1
HTG 60RG115DS	115	4 1/2"		35°	7 x 14	10 x 14	3	-	01-460-115-2565	01-460-115-3001	7,5	1
HTG 60RG115AR	115	4 1/2"		35°	7 x 14	10 x 14	3	-	01-460-115-2566	01-460-115-3398	10,0	1



HTG 60RG95AR



HTG 60RG102A



HTG 60RG102DS



HTG 60RG102AR



HTG 60RG102DSR



HTG 60RG115A



HTG 60RG115DS



HTG 60RG115AR

RG60 BENCH AND PRODUCTION DRILLING - BITS

2 1/3" thread

Forage en gradins et production · Perforación de banco y producción

Бурение промышленных взрывных скважин на открытых и подземных горных работах



RG60 (2 1/3") · threads · filetage · rosca · резьба

Order code	Diameter		Body	Gauge	Buttons		Flushing		Product number		Weight	Pcs/box		
Code produit	Diamètre		Jupe	Périphérie	Boutons		Soufflage		Référence produit		Poids	Pcs/boite		
Código del producto	Diámetro		Cuerpo	Periferia	Botones		Orificios de barrido		Referencia del producto		Peso	Pzas./caja		
Модель	Диаметр		Корпус	Угол	Штыри		Промывочные отверстия		Номер продукции		Вес	Шт./упак.		
	[mm]	[in]		↘	[No.]	[mm]	[No.]	[mm]	[No.]	[No.]	[SuperDome]	[Ballistic]	[kg]	
HTG 60RG115DSR	115	4 1/2"		35°	7	x 14	10	x 14	3	-	01-460-115-2567	01-460-115-3056	10,0	1
HTG 60RG127A	127	5"		35°	8	x 14	10	x 14	3	-	01-460-127-2568	01-460-127-3035	9,4	1
HTG 60RG127DS	127	5"		35°	6	x 16	10	x 16	5	-	01-460-127-2569	01-460-127-2998	9,4	1
HTG 60RG127AR	127	5"		35°	8	x 14	10	x 14	3	-	01-460-127-2570	01-460-127-3037	12,7	1
HTG 60RG127DSR	127	5"		35°	6	x 16	10	x 16	5	-	01-460-127-2075	01-460-127-2076	12,7	1
HTG 60RG140A	140	5 1/2"		35°	10	x 14	12	x 16	3	-	01-460-140-2571	01-460-140-3399	11,1	1
HTG 60RG140DS	140	5 1/2"		35°	6	x 16	10	x 16	5	-	01-460-140-2572	01-460-140-3400	11,1	1
HTG 60RG140AR	140	5 1/2"		35°	10	x 14	12	x 16	3	-	01-460-140-2573	01-460-140-3401	16,1	1



HTG 60RG115DSR



HTG 60RG127A



HTG 60RG127DS



HTG 60RG127AR



HTG 60RG127DSR



HTG 60RG140A



HTG 60RG140DS















HTG 60RG140AR

BITS - BENCH AND PRODUCTION DRILLING RG60

Forage en gradins et production · Perforación de banco y producción 2 1/3" thread
 Бурение промышленных взрывных скважин на открытых и подземных горных работах

RG60 (2 1/3") · threads · filetage · rosca · резьба

Order code	Diameter		Body	Gauge	Buttons		Flushing		Product number		Weight	Pcs/box
Code produit	Diamètre		Juqe	Périphérie	Boutons		Soufflage		Référence produit		Poids	Pcs/boite
Código del producto	Diámetro		Cuerpo	Periferia	Botones		Orificios de barrido		Referencia del producto		Peso	Pzas./caja
Модель	Диаметр		Корпус	Угол	Штыри		Промывочные отверстия		Номер продукции		Вес	Шт./упак.
	[mm]	[in]			 [No.] [mm]	 [No.] [mm]	 [No.]	 [No.]	 [SuperDome]	 [Ballistic]	[kg]	
HTG 60RG140DSR	140	5 1/2"		35°	6 x 16	10 x 16	5	-	01-460-140-2584	01-460-140-2585	16,1	1
HTG 60RG152A	152	6"		35°	10 x 16	12 x 16	3	-	01-460-152-2574	01-460-152-3402	13,2	1
HTG 60RG152DS	152	6"		35°	7 x 16	10 x 16	5	-	01-460-152-2575	01-460-152-3403	13,2	1



HTG 60RG140DSR



HTG 60RG152A



HTG 60RG152DS

RG60 BENCH AND PRODUCTION DRILLING - RODS

2 1/3" thread

Forage en gradins et production · Perforación de banco y producción

Бурение промышленных взрывных скважин на открытых и подземных горных работах

Extension Rod (Male/Female) · Tiges · Barras de extensión · Штанги - **RG60 (2 1/3") bit thread** · filetage · rosca · резьба

Order code	Length	Diameter	Thread	Flushing	Product number	Weight	Pcs/box
Code produit	Longueur	Diamètre	Filetage	Soufflage	Référence produit	Poids	Pcs/boite
Código del producto	Longitud	Diámetro	Rosca	Orificios de barrido	Referencia del producto	Peso	Pzas./caja
Модель	Длина	Диаметр	Резьба	Промывочные отверстия	Номер продукции	Вес	Шт./упак.
	L	D	F				
	[mm] [ft - in]	[mm]	[A] [B]	[mm]		[kg]	

Extension M/F Rod RG60 - round 60 - RG60 (for bits from 96 mm)



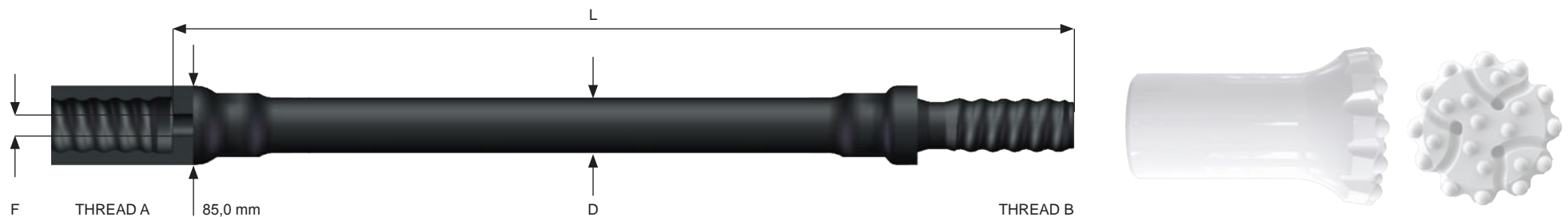









MF-RG60-60R-RG60-3660	3660	12'	RND60	RG60 RG60	22,5	06B-07-3358	74,1	12
MF-RG60-60R-RG60-4265	4265	14'	RND60	RG60 RG60	22,5	06B-07-0502	85,7	12
MF-RG60-60R-RG60-6095	6095	20'	RND60	RG60 RG60	22,5	06B-07-3359	120,5	10



BITS - BENCH AND PRODUCTION DRILLING CT68

Forage en gradins et production · Perforación de banco y producción 2 1/16" thread
 Бурение промышленных взрывных скважин на открытых и подземных горных работах

CT68 (2 1/16") · threads · filetage · rosca · резьба

Order code	Diameter		Body	Gauge	Buttons		Flushing		Product number		Weight	Pcs/box		
Code produit	Diamètre		Jupe	Périphérie	Boutons		Soufflage		Référence produit		Poids	Pcs/boite		
Código del producto	Diámetro		Cuerpo	Periferia	Botones		Orificios de barrido		Referencia del producto		Peso	Pzas./caja		
Модель	Диаметр		Корпус	Угол	Штыри		Промывочные отверстия		Номер продукции		Вес	Шт./упак.		
	[mm]	[in]		↘	 [No.]	[mm]	 [No.]	[mm]	 [No.]	 [No.]	 [SuperDome]	 [Ballistic]	 [kg]	
HTG 68CT102DS	102	4"		35°	7 x 12	9 x 14	3	-	01-368-102-2201	01-368-102-2202	6,2	1		
HTG 68CT115DS	115	4 1/2"		35°	7 x 14	10 x 14	3	-	01-368-115-2576	01-368-115-3408	7,7	1		
HTG 68CT127DS	127	5"		35°	6 x 16	10 x 16	5	-	01-368-127-2577	01-368-115-3409	10,7	1		



HTG 68CT102DS



HTG 68CT115DS



HTG 68CT127DS

SHANK ADAPTERS

Emmanchement · Zancos · Хвостовики



SHANK ADAPTERS

Emmanchement · Zancos · Хвостовики

For rigs of manufacturer:

Atlas Copco · Furukawa · Ingersoll-Rand · Montabert · Sandvik

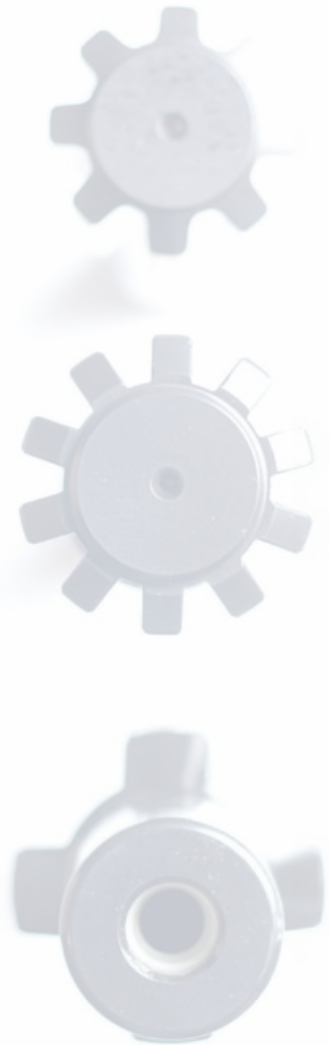

Shank
Adapters



SHANK ADAPTERS

Emmanchement · Zancos · Хвостовики

Index · Index · Índice · Спецификации

Atlas Copco

BBC 43, 44, 45 and 100	61
BBC 51, 52, 54 and 120	61
BBE 57	61
COP 125, 130 and 131	61
COP 1032 HD	62
COP 1032 LE	62
COP 1036/1238/1038 HB	62
COP 1038 HD/1238	63
COP 1038 HL/1238	63
COP 1238	64
COP 1432 (COP 1532, COP1440, COP1838 HD/ME)	64
COP 1432 Female	64
COP 1132	64
COP 1550, COP 1838 ME/ HE	65
COP 1550 EX, COP 1838 EX	65
COP 1840 HE, COP 1850	65
COP 1840 HEX, COP 1850 EX	65
COP 2150, COP 2550	66
COP 2160 EX, COP 2560 EX	66
COP 3038	66

Furukawa

PD 200	67
PD 200R	67
HD 300	67
HD 609	68
HD 612	68
HD 709	68
HD 712	68

Ingersoll-Rand

URD 475	
(URD 550, VL120, EVL 130, VL140 and F16)	69
YH 65, YH 80	69
YH 80 A	69
YH 65 RP (YH 70 RP, YH 75 RP, YH 80 RP)	69

Montabert

H 100	70
HC40	70
HC40 (female)	70
HC 80, HC 90, HC 105	70
HC 80R (HC 105R, HC 107R, HC 108R, HC 109R)	70
HC 120	71
HC 120R, HC 150R, HC 155R, HC 158R	71
HC 200	71
HC 200A	71

Sandvik

HL 300	72
HL 300S	72
L400, L410, L500, L510, L550	72
HLR 438L and HLR 438T	72
HLR 438LS, 438TS, HL 538, HL538L, L550S	73
HL 500-45 / 510-45	73
HL 500 S-38 / 510 S-38 / 510 B / 510 LH	74
HL 500 F / 510 F	74
HL 550 SUPER / 560 SUPER / 510 S-45	74
HLX 5 / HLX 5T	75
HL 600-45 / 600 S-45	75
HL 600-52	75
HL 645	75
HL 650-45 / 700-45 / 700T-45 / 710-45 / 800T-45	75
HL 650-52 (700-52 / PE-52 / S-52, 710-52 / S-52 / PE-52 / SPE-52, 800T-52 / PE-52)	76
HL 850S	77
HL 1000-52 / 1000 S-52	77
HL 1000-60	77
HL 1000 PE-65 / HL 1500 PE-65 / HL 1560 T-65	78
HL 1500-52 / 1500 T-52	78
HL 1500-60 / 1500 T-60	78

ATLAS COPCO - SHANK ADAPTERS

Emmanchement · Zancos · Хвостовики

BBC
BBE
COP

Atlas Copco

Order code Code produit Código del producto Модель	Flushing Soufflage Orificios de barrido Промывочные отверстия	Thread Filetage Rosca Резьба	Length Longueur Longitud Длина	Diameter Diamètre Diámetro Диаметр	Product number Référence produit Referencia del producto Номер продукции	Weight Poids Peso Вес
---	--	---------------------------------------	---	---	---	--------------------------------

	[mm]		[mm]	[mm]		[kg]
			L	D		
BBC 43, 44, 45 and 100	10	R32	380	32	06F-07-3187	1,9
BBC 51, 52, 54 and 120	10	R32	380	38	06F-07-3188	2,6
BBC 51, 52, 54 and 120	10	C38	390	38	06F-07-3189	3,1
BBE 57	14	C38	538	44,5	06F-07-3190	5,3
COP 125, 130 and 131	14	C38	380	38	06F-07-3191	3,0

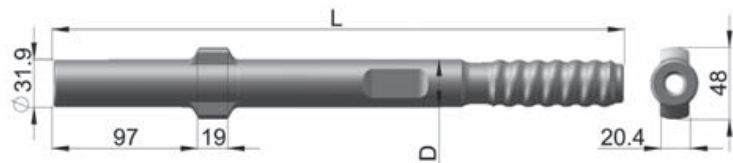

Atlas Copco BBC 43, 44, 45 and 100

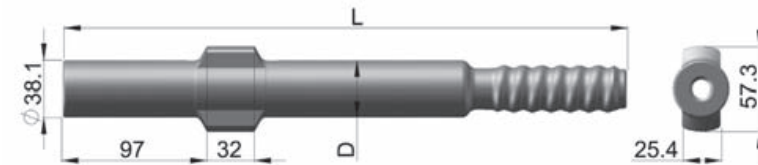

Atlas Copco BBC 51, 52, 54 and 120

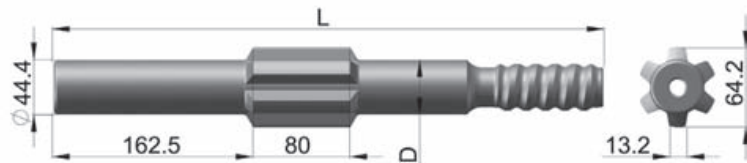

Atlas Copco BBE 57



Atlas Copco COP 125, 130 and 131

Shank
Adapters

COP SHANK ADAPTERS - ATLAS COPCO

Emmanchement · Zancos · Хвостовики

Atlas Copco

Order code	Flushing	Thread	Length	Diameter	Product number	Weight
Code produit	Soufflage	Filetage	Longueur	Diamètre	Référence produit	Poids
Código del producto	Orificios de barrido	Rosca	Longitud	Diámetro	Referencia del producto	Peso
Модель	Промывочные отверстия	Резьба	Длина	Диаметр	Номер продукции	Вес
	[mm]		[mm]	[mm]		[kg]
COP 1032 HD	-	R32	340	45	06F-07-3193	3,4
COP 1032 HD	-	R38	340	55	06F-07-3194	4,1
COP 1032 LE	-	R32	550	45	06F-07-3195	4,8
COP 1036/1238/1038 HB	-	R32	500	38	06F-07-2820	4,0
COP 1036/1238/1038 HB	-	C38	500	38	06F-07-2822	4,4
COP 1036/1238/1038 HB	-	C45	500	45	06F-07-2823	5,0

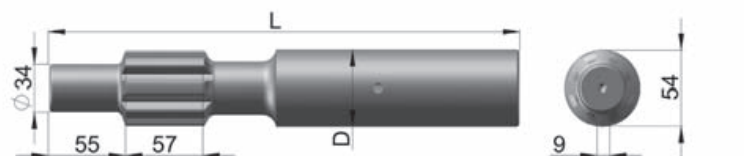

Atlas Copco COP 1032 HD

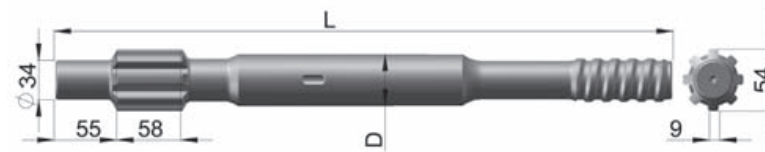

Atlas Copco COP 1032 LE

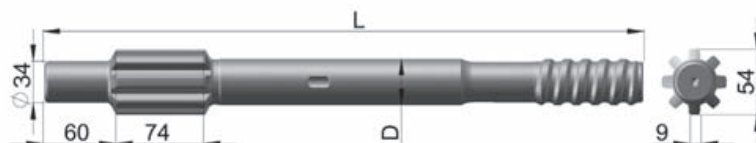

Atlas Copco COP 1036/1238/1038 HB

ATLAS COPCO - SHANK ADAPTERS COP

Emmanchement · Zancos · Хвостовики

Atlas Copco

Order code Code produit Código del producto Модель	Flushing Soufflage Orificios de barrido Промывочные отверстия	Thread Filetage Rosca Резьба	Length Longueur Longitud Длина	Diameter Diamètre Diámetro Диаметр	Product number Référence produit Referencia del producto Номер продукции	Weight Poids Peso Вес
	[mm]		L [mm]	D [mm]		[kg]
COP 1038 HD/1238	-	R32	485	38	06F-07-2429	4,0
COP 1038 HD/1238	-	R38	485	38	06F-07-2720	4,2
COP 1038 HD/1238	-	C38	485	38	06F-07-2430	4,2
COP 1038 HL/1238	-	R32	575	38	06F-07-2828	4,6
COP 1038 HL/1238	-	C38	575	38	06F-07-2829	4,9
COP 1038 HL/1238	-	C45	575	45	06F-07-2834	5,8

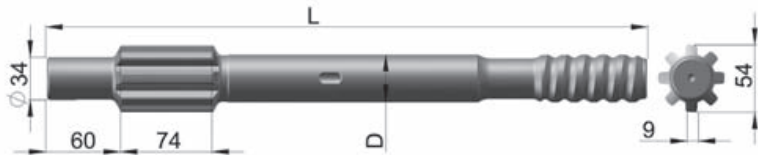

Atlas Copco COP 1038 HD/1238



Atlas Copco COP 1038 HL/1238



Atlas Copco COP 1038 HL (C45)/1238

Shank
Adapters

COP SHANK ADAPTERS - ATLAS COPCO

Emmanchement · Zancos · Хвостовики

Atlas Copco

Order code	Flushing	Thread	Length	Diameter	Product number	Weight
Code produit	Soufflage	Filetage	Longueur	Diamètre	Référence produit	Poids
Código del producto	Orificios de barrido	Rosca	Longitud	Diámetro	Referencia del producto	Peso
Модель	Промывочные отверстия	Резьба	Длина	Диаметр	Номер продукции	Вес
	[mm]		[mm]	[mm]		[kg]
COP 1238	-	C38	575	45	06F-07-2833	4,9
COP 1432,	-	R32	435	38	06F-07-2431	3,6
(COP 1532,	-	R38	435	38	06F-07-2719	3,9
COP1440,	-	C38	435	38	06F-07-0487	3,9
COP1838	-	R32	525	38	06F-07-2432	4,5
HD/ME)	-	C38	525	38	06F-07-2662	4,7
COP 1432 Female	-	R32	341	55	06F-07-3371	4,4
COP 1432 Female	-	R38	341	55	06F-07-3372	4,7
COP 1132	-	R32	410	35	06F-07-3118	2,5



Atlas Copco COP 1238 (L=575)



Atlas Copco COP 1432, COP 1532, COP1440, COP1838 HD/ME

ATLAS COPCO - SHANK ADAPTERS COP

Emmanchement · Zancos · Хвостовики

Atlas Copco

Order code Code produit Código del producto Модель	Flushing Soufflage Orificios de barrido Промывочные отверстия	Thread Filetage Rosca Резьба	Length Longueur Longitud Длина	Diameter Diamètre Diámetro Диаметр	Product number Référence produit Referencia del producto Номер продукции	Weight Poids Peso Вес
	[mm]		L [mm]	D [mm]		[kg]
COP 1550, COP 1838 ME/ HE	-	C38	525	52	06F-07-2838	5,9
COP 1550, COP 1838 ME/ HE	-	C45	525	52	06F-07-2337	6,1
COP 1550, COP 1838 ME/ HE	-	C51	525	52	06F-07-2839	6,5
COP 1550 EX, COP 1838 EX	-	C38	730	60	06F-07-3196	9,8
COP 1550 EX, COP 1838 EX	-	C45	730	60	06F-07-3197	10,2
COP 1840 HE, COP 1850	-	C38	565	52	06F-07-2840	6,5
COP 1840 HE, COP 1850	-	C45	565	52	06F-07-2841	6,9
COP 1840 HE, COP 1850	-	C51	565	52	06F-07-0472	7,1

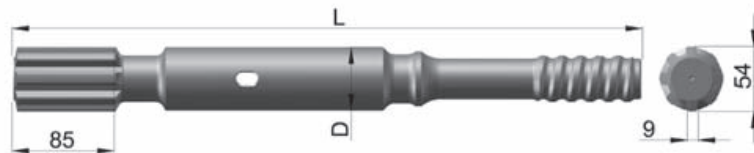

Atlas Copco COP 1550, COP 1838 ME/ HE

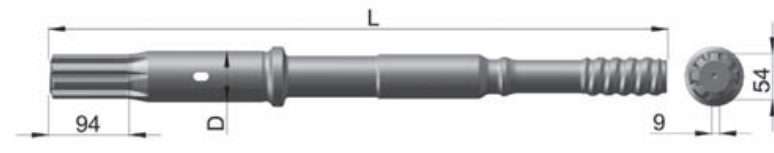

Atlas Copco COP 1550 EX, COP 1838 EX

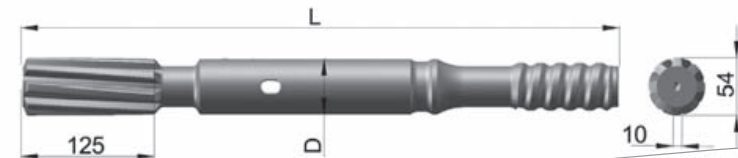

Atlas Copco COP 1840 HE, COP 1850

Shank Adapters

COP SHANK ADAPTERS - ATLAS COPCO

Emmanchement · Zancos · Хвостовики

Atlas Copco

Order code	Flushing	Thread	Length	Diameter	Product number	Weight
Code produit	Soufflage	Filetage	Longueur	Diamètre	Référence produit	Poids
Código del producto	Orificios de barrido	Rosca	Longitud	Diámetro	Referencia del producto	Peso
Модель	Промывочные отверстия	Резьба	Длина	Диаметр	Номер продукции	Вес
	[mm]		[mm]	[mm]		[kg]
COP 1840 HEX, COP 1850 EX	-	C45	770	60	06F-07-2740	10,9
COP 1840 HEX, COP 1850 EX	-	C51	770	60	06F-07-3373	11,2
COP 2150, COP 2550	-	C51	770	52	06F-07-3374	9,9
COP 2160 EX, COP 2560 EX	-	C45	770	63	06F-07-3375	13,3
COP 2160 EX, COP 2560 EX	-	C51	770	63	06F-07-3376	13,5
COP 3038	-	C38	435	45	06F-07-5599	5,1
COP 3038	-	C38	525	45	06F-07-5600	5,3



Atlas Copco COP 1840 HEX, COP 1850 EX

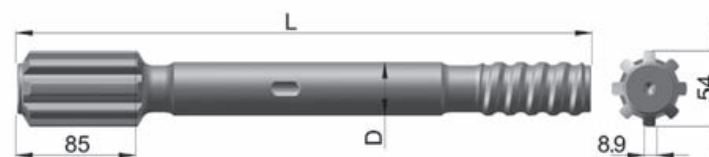

Atlas Copco COP 3038

FURUKAWA - SHANK ADAPTERS

Emmanchement · Zancos · Хвостовики

PD
HD

Furukawa

Order code Code produit Código del producto Модель	Flushing Soufflage Orificios de barrido Промывочные отверстия	Thread Filetage Rosca Резьба	Length Longueur Longitud Длина	Diameter Diamètre Diámetro Диаметр	Product number Référence produit Referencia del producto Номер продукции	Weight Poids Peso Вес
	[mm]		L [mm]	D [mm]		[kg]
PD 200	14	R32	330	44,5	06F-07-3198	3,3
PD 200	14	C38	380	44,5	06F-07-3199	3,7
PD 200	14	C38	446	44,5	06F-07-0480	4,5
PD 200R	14	C38	485	44	06F-07-0478	4,8
HD 300	16	C38	655	45	06F-07-3200	6,2
HD 300	16	C45	655	45	06F-07-3201	6,5

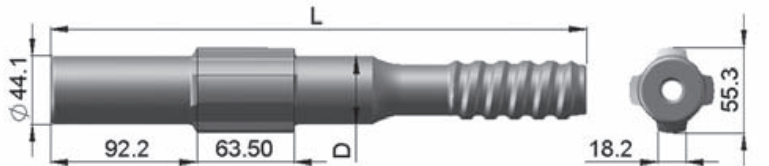

Furukawa PD 200 (L=330)

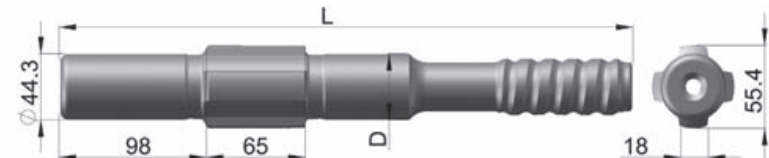

Furukawa PD 200

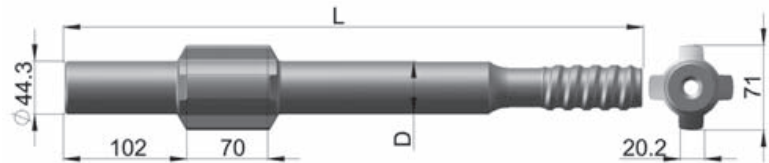

Furukawa PD 200R

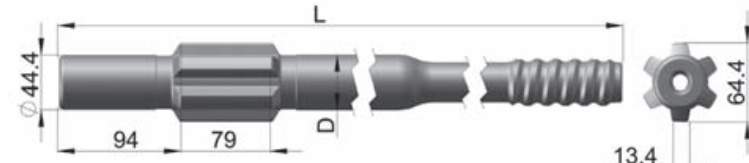

Furukawa HD 300

Shank
Adapters

Furukawa

Order code Code produit Código del producto Модель	Flushing Soufflage Orificios de barrido Промывочные отверстия	Thread Filetage Rosca Резьба	Length Longueur Longitud Длина	Diameter Diamètre Diámetro Диаметр	Product number Référence produit Referencia del producto Номер продукции	Weight Poids Peso Вес
	[mm]		L [mm]	D [mm]		[kg]
HD 609	-	C38	620	45	06F-07-2844	6,0
HD 609	-	C38	690	45	06F-07-3202	6,4
HD 609	-	C45	620	45	06F-07-2845	6,6
HD 612	-	C45	710	50,8	06F-07-2742	8,7
HD 709	-	C38	620	45	06F-07-2846	6,1
HD 712	-	C45	790	51	06F-07-2200	10,5

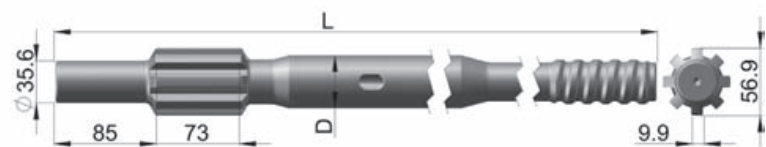

Furukawa HD 609

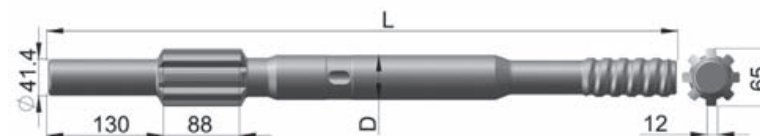

Furukawa HD 612



Furukawa HD 709



Furukawa HD 712

INGERSOLL-RAND - SHANK ADAPTERS URD

Emmanchement · Zancos · Хвостовики

YH

Ingersoll-Rand

Order code	Flushing	Thread	Length	Diameter	Product number	Weight
Code produit	Soufflage	Filetage	Longueur	Diamètre	Référence produit	Poids
Código del producto	Orificios de barrido	Rosca	Longitud	Diámetro	Referencia del producto	Peso
Модель	Промывочные отверстия	Резьба	Длина	Диаметр	Номер продукции	Вес

	[mm]		[mm]	[mm]		[kg]
URD 475 (URD 550, VL120, EVL 130, VL140 and F16)	14	R32	330	44,5	06F-07-3198	3,3
	14	R32	380	44,5	06F-07-3377	3,7
	14	C38	380	44,5	06F-07-3199	3,7
	14	C38	446	44,5	06F-07-0480	4,5
YH 65, YH 80	19	C38	495	45	06F-07-0476	5,0
YH 65, YH 80	19	C45	495	45	06F-07-2713	5,4
YH 80 A	19	C45	495	51	06F-07-2714	5,9
YH 65 RP (YH 70 RP, YH 75 RP, YH 80 RP)	19	C45	700	45	06F-07-4450	8,0

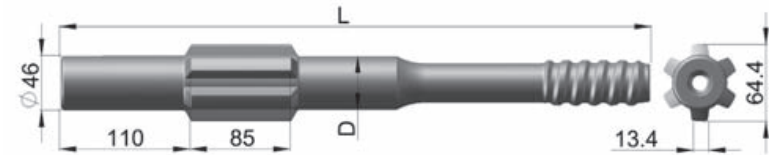

Ingersoll-Rand YH 65, YH 80

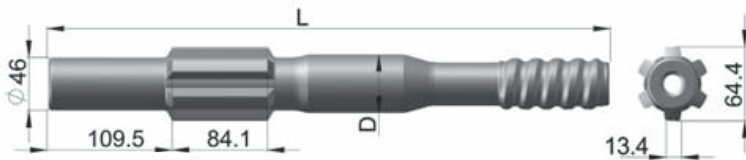

Ingersoll-Rand YH 80 A

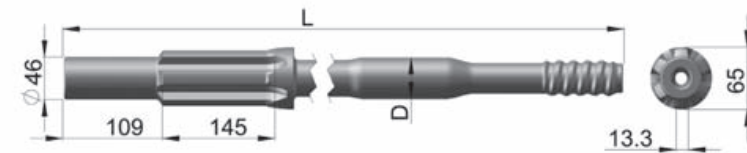

Ingersoll-Rand YH 65 RP, YH 70 RP, YH 75 RP, YH 80 RP

Shank Adapters

SHANK ADAPTERS - MONTABERT

Emmanchement · Zancos · Хвостовики

Montabert

Order code Code produit Código del producto Модель	Flushing Soufflage Orificios de barrido Промывочные отверстия	Thread Filetage Rosca Резьба	Length Longueur Longitud Длина	Diameter Diamètre Diámetro Диаметр	Product number Référence produit Referencia del producto Номер продукции	Weight Poids Peso Вес
	[mm]		L [mm]	D [mm]		[kg]
H 100	14	C38	537	44,5	06F-07-3382	5,3
HC40	-	R32	447	38	06F-07-2741	3,5
HC40	-	R38	447	38	06F-07-2849	3,7
HC40 (female)	-	R32	270	52,5	06F-07-3380	4,1
HC 80, HC 90, HC 105	-	R38	440	38	06F-07-2144	3,9
HC 80, HC 90, HC 105	-	C38	450	38	06F-07-2434	4,0
HC 80, HC 90, HC 105	-	C38	500	38	06F-07-3381	4,2
HC 80R (HC 105R, HC 107R, HC 108R, HC 109R)	-	C45	670	45	06F-07-2715	7,9



Montabert HC40

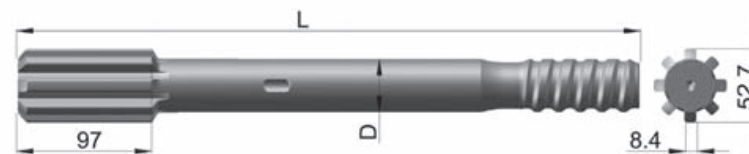

Montabert HC 80, HC 90, HC 105

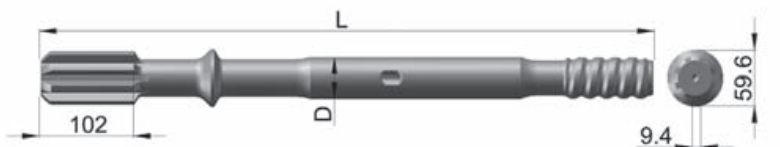

Montabert HC 80R, HC 105R, HC 107R, HC 108R, HC 109R

MONTABERT - SHANK ADAPTERS

HC

Emmanchement · Zancos · Хвостовики

Montabert

Order code Code produit Código del producto Модель	Flushing Soufflage Orificios de barrido Промывочные отверстия	Thread Filetage Rosca Резьба	Length Longueur Longitud Длина	Diameter Diamètre Diámetro Диаметр	Product number Référence produit Referencia del producto Номер продукции	Weight Poids Peso Вес
	[mm]		L [mm]	D [mm]		[kg]
HC 80, HC 120	-	C45	490	45	06F-07-3204	5,8
HC 120R, HC 150R, HC 155R, HC 158R	-	C51	670	51	06F-07-2032	9,3
HC 200	-	C51	840	50,9	06F-07-2743	13,6
HC 200A	-	RG60	850	60	06F-07-3205	16,8

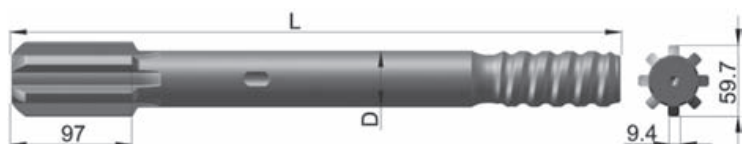

Montabert HC 80, HC 120



Montabert HC 120R, HC 150R, HC 155R, HC 158R

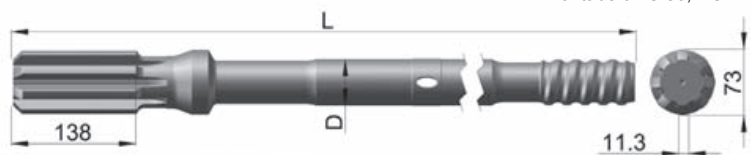

Montabert HC 200

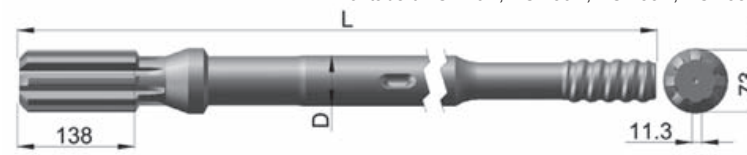

Montabert HC 200A

Shank
Adapters

HL SHANK ADAPTERS - SANDVIK

HLR Emmanchement · Zancos · Хвостовики

L

Sandvik

Order code Code produit Código del producto Модель	Flushing Soufflage Orificios de barrido Промывочные отверстия	Thread Filetage Rosca Резьба	Length Longueur Longitud Длина	Diameter Diamètre Diámetro Диаметр	Product number Référence produit Referencia del producto Номер продукции	Weight Poids Peso Вес
	[mm]		L [mm]	D [mm]		[kg]
HL 300	-	R32	400	32	06F-07-2771	2,6
HL 300S	-	R32	245	45	06F-07-2198	2,6
L400, L410, L500, L510, L550	10	R32	380	32	06F-07-2776	2,0
HLR 438L and HLR 438T	12,07	R32	380	38	06F-07-2777	3,8
HLR 438L and HLR 438T	12,07	C38	400	38	06F-07-2778	4,1

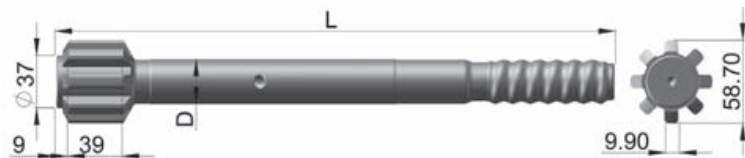

HL 300



HL 300S



L400, L410, L500, L510, L550

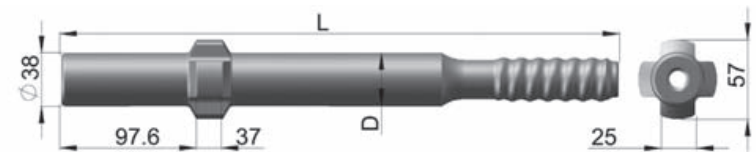

HLR 438L and HLR 438T

SANDVIK - SHANK ADAPTERS

Emmanchement · Zancos · Хвостовики

HL
HLR
L

Sandvik

Order code Code produit Código del producto Модель	Flushing Soufflage Orificios de barrido Промывочные отверстия	Thread Filetage Rosca Резьба	Length Longueur Longitud Длина	Diameter Diamètre Diámetro Диаметр	Product number Référence produit Referencia del producto Номер продукции	Weight Poids Peso Вес
	[mm]		L [mm]	D [mm]		[kg]
HLR 438LS, 438TS, HL 538, HL538L, L550S	-	R32	450	38	06F-07-2780	3,8
HLR 438LS, 438TS, HL 538, HL538L, L550S	-	R38	450	38	06F-07-2781	4,0
HLR 438LS, 438TS, HL 538, HL538L, L550S	-	C38	455	38	06F-07-2783	4,1
HLR 438LS, 438TS, HL 538, HL538L, L550S	-	C38	545	38	06F-07-3432	4,7
HL 500-45 / 510-45	-	R32	550	45	06F-07-2494	5,3
HL 500-45 / 510-45	-	C38	550	45	06F-07-0483	5,3
HL 500-45 / 510-45	-	C45	550	45	06F-07-2527	5,8

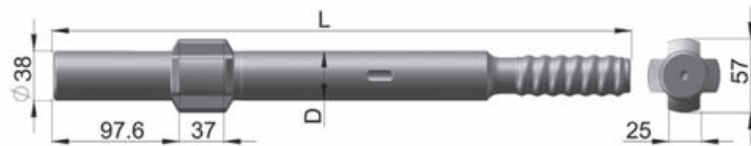

HLR 438LS, 438TS, HL 538, HL538L, L550S

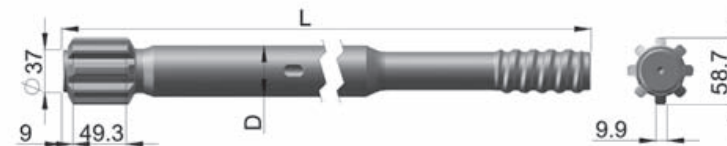

HL 500-45 / 510-45

Shank
Adapters

HL SHANK ADAPTERS - SANDVIK

Emmanchement · Zancos · Хвостовики

Sandvik

Order code	Flushing	Thread	Length	Diameter	Product number	Weight
Code produit	Soufflage	Filetage	Longueur	Diamètre	Référence produit	Poids
Código del producto	Orificios de barrido	Rosca	Longitud	Diámetro	Referencia del producto	Peso
Модель	Промывочные отверстия	Резьба	Длина	Диаметр	Номер продукции	Вес
	[mm]		L [mm]	D [mm]		[kg]
HL 500 S-38 / 510 S-38 / 510 B / 510 LH	-	R32	460	38	06F-07-2335	3,7
HL 500 S-38 / 510 S-38 / 510 B / 510 LH	-	R38	460	38	06F-07-2721	3,9
HL 500 S-38 / 510 S-38 / 510 B / 510 LH	-	C38	460	38	06F-07-2371	4,0
HL 500 S-38 / 510 S-38 / 510 B / 510 LH	-	R38	500	38	06F-07-2787	3,9
HL 500 S-38 / 510 S-38 / 510 B / 510 LH	-	C38	500	38	06F-07-2788	4,0
HL 500 F / 510 F	-	R32	350	45	06F-07-3361	3,9
HL 550 SUPER / 560 SUPER / 510 S-45	-	R38	500	45	06F-07-2789	5,3
HL 550 SUPER / 560 SUPER / 510 S-45	-	C38	500	45	06F-07-2790	5,3



HL 500 S-38 / 510 S-38 / 510 B / 510 LH

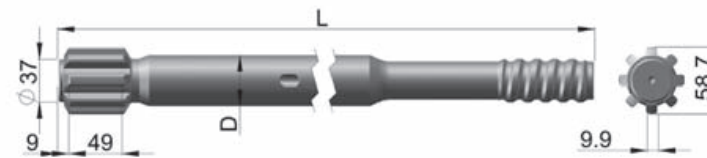

HL 550 SUPER / 560 SUPER / 510 S-45

SANDVIK - SHANK ADAPTERS

Emmanchement · Zancos · Хвостовики

HL
HLX

Sandvik

Order code Code produit Código del producto Модель	Flushing Soufflage Orificios de barrido Промывочные отверстия	Thread Filetage Rosca Резьба	Length Longueur Longitud Длина	Diameter Diamètre Diámetro Диаметр	Product number Référence produit Referencia del producto Номер продукции	Weight Poids Peso Вес
	[mm]		L [mm]	D [mm]		[kg]
HLX 5 / HLX 5T	-	R32	500	45	06F-07-2791	5,1
HLX 5 / HLX 5T	-	C38	500	45	06F-07-2334	5,1
HLX 5 / HLX 5T	-	R38	500	45	06F-07-2792	5,2
HLX 5 / HLX 5T	-	R32	575	45	06F-07-2793	5,5
HLX 5 / HLX 5T	-	C38	575	45	06F-07-2795	5,7
HLX 5 / HLX 5T	-	C45	575	45	06F-07-4837	5,8
HL 600-45 / 600 S-45	-	R32	600	45	06F-07-2796	6,3
HL 600-45 / 600 S-45	-	C38	600	45	06F-07-2798	6,4
HL 600-45 / 600 S-45	-	C45	600	45	06F-07-2799	6,4
HL 600-45 / 600 S-45	-	C38	525	45	06F-07-2797	5,7
HL 600-45 / 600 S-45	-	C45	525	45	06F-07-2800	5,8

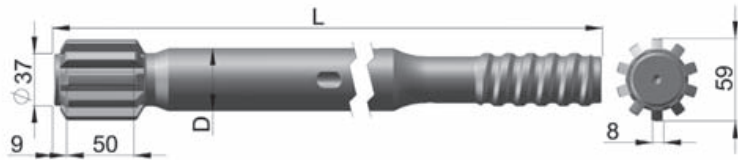

HLX 5 / HLX 5T

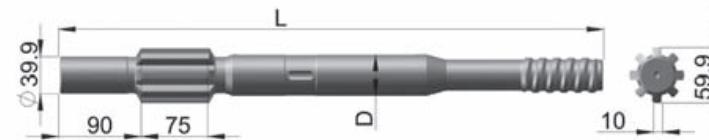

HL 600-45 / 600 S-45

Shank
Adapters

HL SHANK ADAPTERS - SANDVIK

Emmanchement · Zancos · Хвостовики

Sandvik

Order code Code produit Código del producto Модель	Flushing Soufflage Orificios de barrido Промывочные отверстия	Thread Filetage Rosca Резьба	Length Longueur Longitud Длина	Diameter Diamètre Diámetro Диаметр	Product number Référence produit Referencia del producto Номер продукции	Weight Poids Peso Вес
	[mm]		L [mm]	D [mm]		[kg]
HL 600-52	-	C45	650	52	06F-07-2801	6,4
HL 600-52	-	C51	650	52	06F-07-2802	6,4
HL 645	-	C38	600	45	06F-07-2803	6,6
HL 645	-	C45	600	45	06F-07-2804	6,9
HL 650-45 / 700-45 / 700T-45 / 710-45 / 800T-45	-	C38	600	45	06F-07-2805	7,0
HL 650-45 / 700-45 / 700T-45 / 710-45 / 800T-45	-	C45	600	45	06F-07-2806	7,5
HL 650-52 (700-52 / PE-52 / S-52, 710-52 / S-52 / PE-52 / SPE-52, 800T-52 / PE-52)	-	C38	600	52	06F-07-0482	8,0
	-	C45	600	52	06F-07-2182	8,5
	-	C51	600	52	06F-07-2331	8,6



HL 600-52



HL 645

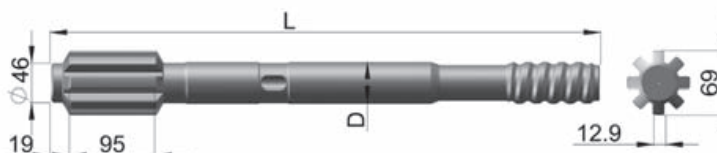

HL 650-45 / 700-45 / 700T-45 / 710-45 / 800T-45

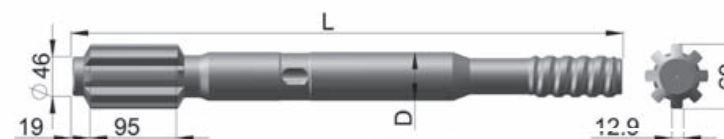

HL 650-52, 700-52 / PE-52 / S-52, 710-52 / S-52 / PE-52 / SPE-52, 800T-52 / PE-52

SANDVIK - SHANK ADAPTERS

HL

Emmanchement · Zancos · Хвостовики

Sandvik

Order code Code produit Código del producto Модель	Flushing Soufflage Orificios de barrido Промывочные отверстия	Thread Filetage Rosca Резьба	Length Longueur Longitud Длина	Diameter Diamètre Diámetro Диаметр	Product number Référence produit Referencia del producto Номер продукции	Weight Poids Peso Вес
	[mm]		L [mm]	D [mm]		[kg]
HL 850S	-	C45	670	52	06F-07-2810	9,5
HL 1000-52 / 1000 S-52	-	C45	670	52	06F-07-2812	10,0
HL 1000-52 / 1000 S-52	-	C51	670	52	06F-07-2814	10,7
HL 1000-52 / 1000 S-52	-	C45	590	52	06F-07-2811	8,9
HL 1000-52 / 1000 S-52	-	C51	590	52	06F-07-2813	9,3
HL 1000-60	-	C51	670	60	06F-07-2815	12,5
HL 1000-60	-	RG60	670	60	06F-07-3360	12,9

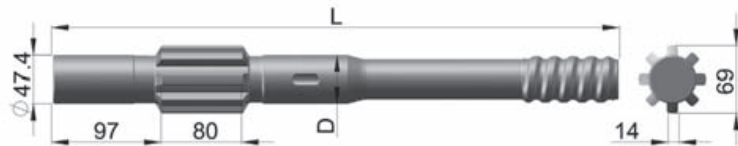

HL 850S

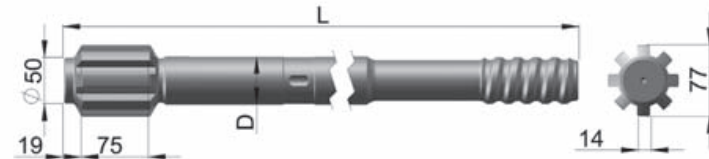

HL 1000-52 / 1000 S-52

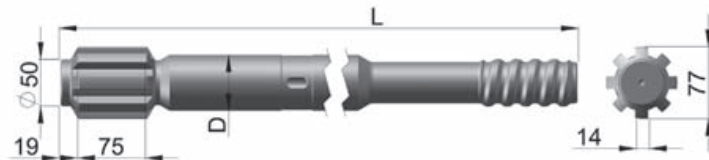

HL 1000-60

Shank
Adapters

HL SHANK ADAPTERS - SANDVIK

Emmanchement · Zancos · Хвостовики

Sandvik

Order code Code produit Código del producto Модель	Flushing Soufflage Orificios de barrido Промывочные отверстия	Thread Filetage Rosca Резьба	Length Longueur Longitud Длина	Diameter Diamètre Diámetro Диаметр	Product number Référence produit Referencia del producto Номер продукции	Weight Poids Peso Вес
			L [mm]	D [mm]		[kg]
HL 1000 PE-65 / HL 1500 PE-65 / HL 1560 T-65	-	C51	760	65	06F-07-3186	15,9
HL 1000 PE-65 / HL 1500 PE-65 / HL 1560 T-65	-	RG60	760	65	06F-07-3232	16,9
HL 1500-52 / 1500 T-52	-	C51	710	52	06F-07-2816	11,2
HL 1500-60 / 1500 T-60	-	C51	760	60	06F-07-3363	13,3
HL 1500-60 / 1500 T-60	-	RG60	760	60	06F-07-3364	14,7
HL 1500-80 / 1500 T-80	-	RG60	760	80	06F-07-5460	21,0

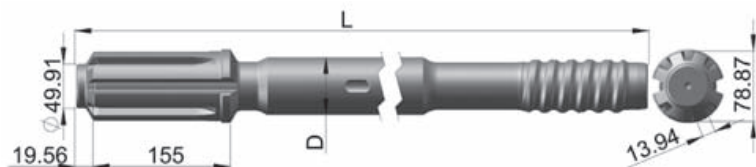

HL 1000 PE-65 / HL 1500 PE-65 / HL 1560 T-65

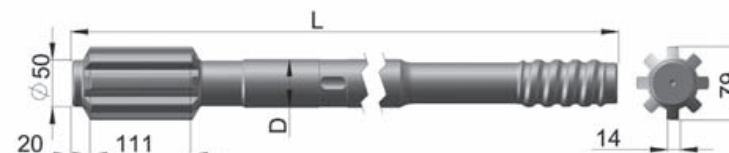

HL 1500-52 / 1500 T-52

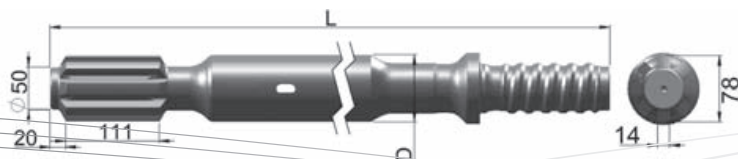

HL 1500-80 / HL 1500 T-80

Shank
Adapters

AUXILIARY TOOLS

Accessoires · Accesorios · Вспомогательный инструмент



AUXILIARY TOOLS

Accessoires · Accesorios · Вспомогательный инструмент

Guide adapters - Button bit adapters - Couplings - Grinding cups

Adaptateurs guides - Adaptateurs pour taillants à boutons - Manchons - Meules d'affûtage · Adaptadores guía - Adaptadores para broca - Cople - Copas de afilado
· Направляющие адаптеры - Адаптеры к штыревым коронкам - Муфты - Заточные колпачки

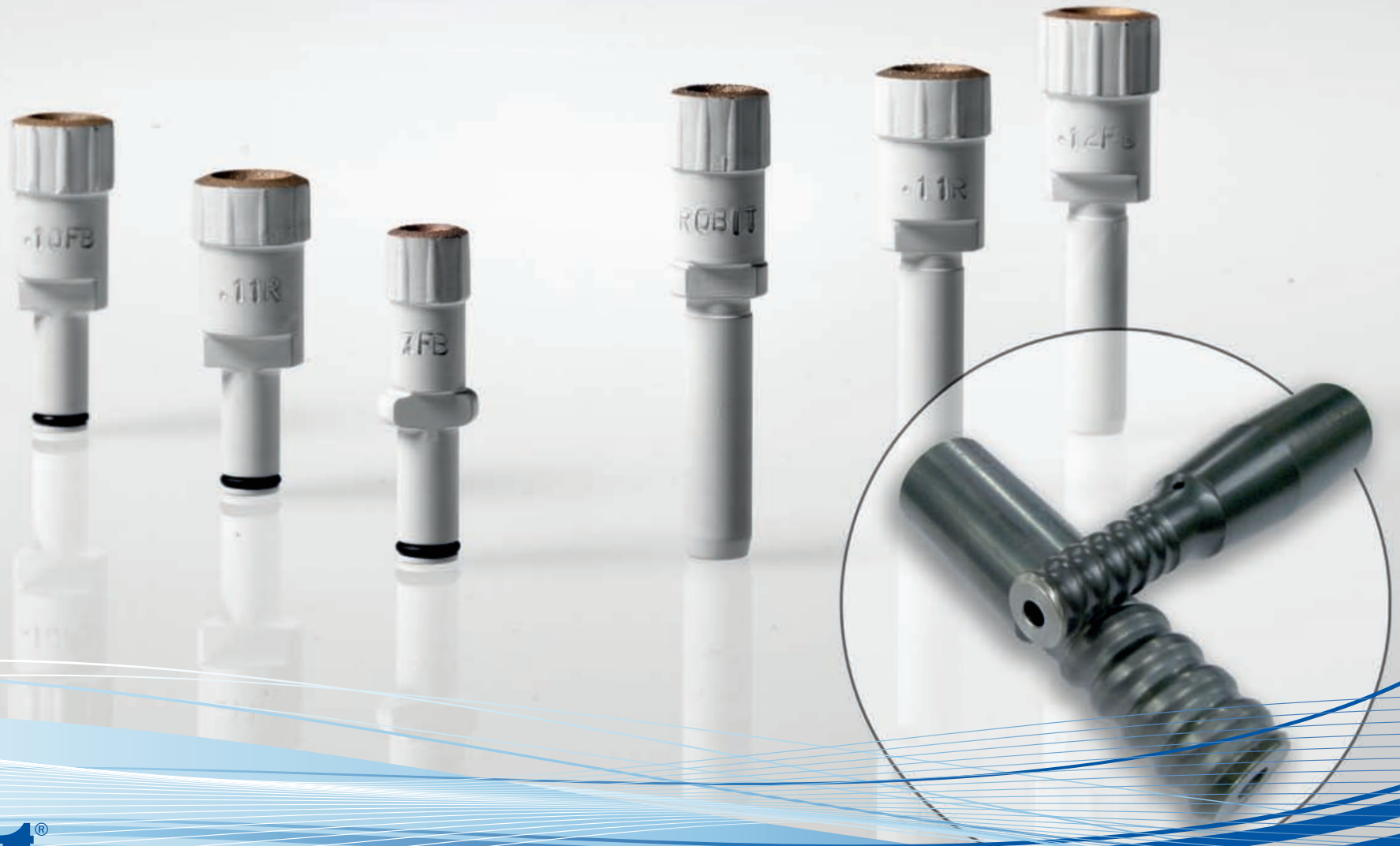



AUXILIARY TOOLS - GUIDE ADAPTERS

Adapteurs guides · Adaptadores guía · Направляющие адаптеры

Guide adapters · Adapteurs guides · Adaptadores guía · Направляющие адаптеры

Order code	Bit diameter	Thread	Length	Diameter	Product number	Weight
Code produit	Diamètre taillant	Filetage	Longueur	Diamètre	Référence produit	Poids
Código del producto	Diámetro de la broca	Rosca	Longitud	Diámetro	Referencia del producto	Peso
Модель	Диам. Коронки	Резьба	Длина	Диаметр	Номер продукции	Вес
	[mm]		L [mm]	D [mm]		[kg]
Guide adapter MF-38C62-410	64	C38	410	62	01-238-238-1112	6,0
Guide adapter MF-45C68-410	70	C45	410	68	01-245-245-3282	6,9
Guide adapter MF-45C72-410	76	C45	410	72	01-245-245-2345	7,8
Guide adapter MF-51C79-410	83	C51	410	79	01-251-251-1315	10,2
Guide adapter MF-51C83-410	89	C51	410	83	01-251-251-3531	11,5
Guide adapter MF-51C96-410	102	C51	410	96	01-251-251-3153	13,5

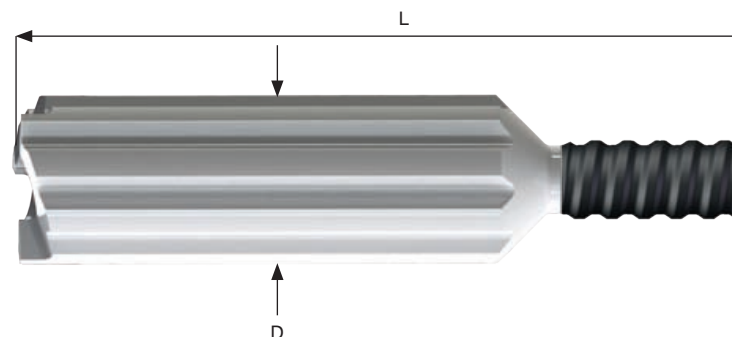
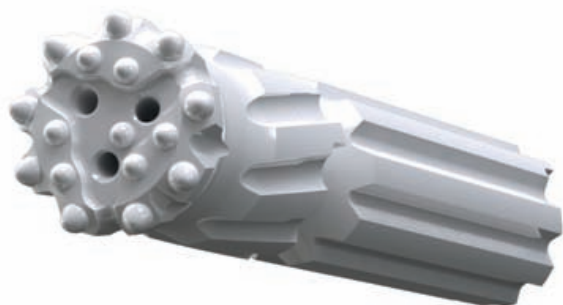

BUTTON BIT ADAPTERS - AUXILIARY TOOLS

Adaptateurs pour taillants à boutons · Adaptadores para broca · Адаптеры к штыревым коронкам



Button bit adapters · Adaptateurs pour taillants à boutons · Adaptadores para broca · Адаптеры к штыревым коронкам

Order code	Female thread	Male thread	Length	Diameter	Product number	Weight
Code produit	Filetage femelle	Filetage mâle	Longueur	Diamètre	Référence produit	Poids
Código del producto	Rosca hembra	Rosca macho	Longitud	Diámetro	Referencia del producto	Peso
Модель	Внутренняя резьба	Наружная резьба	Длина [mm]	Диаметр [mm]	Номер продукции	Вес [kg]

R-series

R25 F-R28 M	R25	R28	173	45	06E-07-3405	1,1
R25 F-R32 M	R25	R32	173	45	06E-07-3406	1,2
R28 F-R32 M	R28	R32	165	44	06E-07-3407	1,5
R32 F-R38 M	R32	R38	225	45	06E-07-2869	1,8
R32 F-C38 M	R32	C38	225	45	06E-07-2870	1,9
R38 F-R32 M	R38	R32	245	55	06E-07-2871	2,2
R38 F-C38 M	R38	C38	245	55	06E-07-2872	2,4

C-series

C38 F-R32 M	C38	R32	247	57	06E-07-0499	2,2
C38 F-R38 M	C38	R38	280	57	06E-07-2873	2,7
C38 F-C45 M	C38	C45	285	57	06E-07-2311	2,9
C45 F-C38 M	C45	C38	265	63	06E-07-0838	2,9
C45 F-C51 M	C45	C51	285	63	06E-07-2874	3,6
C51 F-C45 M	C51	C45	285	71	06E-07-2875	4,0





AUXILIARY TOOLS - COUPLINGS

Manchons · Coples · Муфты

Coupling sleeve · Manchons · Coples · Муфты

Order code Code produit Código del producto Модель	Thread Filetage Rosca Резьба	Thread Filetage Rosca Резьба	Length Longueur Longitud Длина	Diameter Diametre Diámetro Диаметр	Bridge Ponté Puente Тип соединения	Product number Référence produit Referencia del producto Номер продукции	Weight Poids Peso Вес
	A	B	L [mm]	D [mm]			[kg]
Coupling R25	R25	R25	150	35	S	06E-07-2856	0,7
Coupling R28	R28	R28	150	40	S	06E-07-2855	0,9
Coupling R32	R32	R32	150	44	S	06E-07-0496	1,0
Coupling R38	R38	R38	170	55	S	06E-07-0495	1,9
Coupling C38	C38	C38	190	55	S	06E-07-0497	2,0
Coupling C45	C45	C45	210	63	S	06E-07-0889	2,8
Coupling C45	C45	C45	210	66	S	06E-07-2854	3,1
Coupling C51	C51	C51	225	72	S	06E-07-2853	3,8
Coupling C51	C51	C51	225	77	S	06E-07-0494	4,7

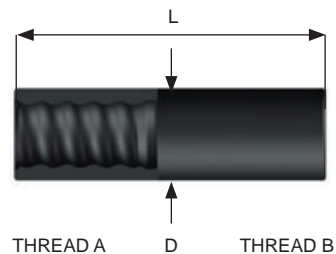

COUPLINGS - AUXILIARY TOOLS

Manchons · Cople Adaptador · Муфты



Coupling adapter · Manchons réducteurs · Cople Adaptador · Адаптер к муфте

Order code Code produit Código del producto Модель	Thread Filetage Rosca Резьба	Thread Filetage Rosca Резьба	Length Longueur Longitud Длина	Diameter Diametre Diámetro Диаметр	Bridge Ponté Puente Тип соединения	Product number Référence produit Referencia del producto Номер продукции	Weight Poids Peso Вес
	A	B	L [mm]	D [mm]			[kg]
Coupling R28-R25	R28	R25	160	40	F	06E-07-3386	0,9
Coupling R32-R25	R32	R25	160	44	F	06E-07-2857	1,2
Coupling R32-R28	R32	R28	160	44	F	06E-07-3387	1,2
Coupling R38-R32	R38	R32	180	55	F	06E-07-2660	1,7
Coupling C38-R32	C38	R32	190	55	F	06E-07-2863	1,7
Coupling C38-R38	C38	R38	190	55	F	06E-07-2865	1,9
Coupling C45-C38	C45	C38	206	63	F	06E-07-3388	3,0
Coupling C51-C45	C51	C45	225	72	F	06E-07-3389	3,8

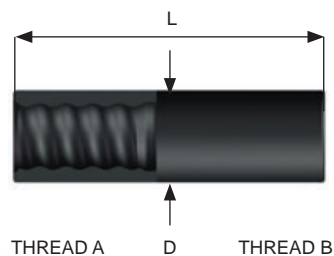



AUXILIARY TOOLS - GRINDING CUPS

Meules d'affûtage · Copas de afilado · Заточные колпачки

Grinding cups · Meules d'affûtage · Copas de afilado · Заточные колпачки

Order code	Product number	Weight	Order code	Product number	Weight
Code produit	Référence produit	Poids	Code produit	Référence produit	Poids
Código del producto	Referencia del producto	Peso	Código del producto	Referencia del producto	Peso
Модель	Номер продукции	Вес	Модель	Номер продукции	Вес
		[kg]			[kg]
SANDRIVE SHAFT			SANDRIVE SHAFT		
Round · ronds · esféricos · сферическими			Ballistic · balistiques · balísticos · баллистическими		
Sandrive 7 mm Round	06K-21-3410	0,03	Sandrive 7 mm Ballistic	06K-21-0716	0,03
Sandrive 8 mm Round	06K-21-0750	0,03	Sandrive 8 mm Ballistic	06K-21-0711	0,03
Sandrive 9 mm Round	06K-21-0747	0,04	Sandrive 9 mm Ballistic	06K-21-0707	0,04
Sandrive 10 mm Round	06K-21-0782	0,05	Sandrive 10 mm Ballistic	06K-21-0740	0,05
Sandrive 11 mm Round	06K-21-0779	0,05	Sandrive 11 mm Ballistic	06K-21-0735	0,05
Sandrive 12 mm Round	06K-21-0775	0,06	Sandrive 12 mm Ballistic	06K-21-0731	0,06
Sandrive 13 mm Round	06K-21-0770	0,06	Sandrive 13 mm Ballistic	06K-21-0729	0,06
Sandrive 14 mm Round	06K-21-0766	0,07	Sandrive 14 mm Ballistic	06K-21-0725	0,07
Sandrive 16 mm Round	06K-21-0760	0,08	Sandrive 16 mm Ballistic	06K-21-0722	0,08
Sandrive 18 mm Round	06K-21-0758	0,09	Sandrive 18 mm Ballistic	06K-21-0720	0,09
WINGDRIVE SHAFT			WINGDRIVE SHAFT		
Round · ronds · esféricos · сферическими			Ballistic · balistiques · balísticos · баллистическими		
Wingdrive 7 mm Round	06K-21-0899	0,03	Wingdrive 7 mm Ballistic	06K-21-0717	0,03
Wingdrive 8 mm Round	06K-21-0751	0,03	Wingdrive 8 mm Ballistic	06K-21-0712	0,03
Wingdrive 9 mm Round	06K-21-0748	0,04	Wingdrive 9 mm Ballistic	06K-21-0708	0,04
Wingdrive 10 mm Round	06K-21-0783	0,05	Wingdrive 10 mm Ballistic	06K-21-0741	0,05
Wingdrive 11 mm Round	06K-21-0780	0,05	Wingdrive 11 mm Ballistic	06K-21-0736	0,05
Wingdrive 12 mm Round	06K-21-0776	0,06	Wingdrive 12 mm Ballistic	06K-21-0732	0,06
Wingdrive 13 mm Round	06K-21-0771	0,06	Wingdrive 13 mm Ballistic	06K-21-0746	0,06
Wingdrive 14 mm Round	06K-21-0767	0,07	Wingdrive 14 mm Ballistic	06K-21-0726	0,07
Wingdrive 16 mm Round	06K-21-0761	0,08	Wingdrive 16 mm Ballistic	06K-21-0745	0,08
Wingdrive 18 mm Round	06K-21-0756	0,09	Wingdrive 18 mm Ballistic	06K-21-3411	0,09

GRINDING CUPS - AUXILIARY TOOLS

Meules d'affûtage · Copas de afilado · Заточные колпачки



Grinding cups · Meules d'affûtage · Copas de afilado · Заточные колпачки

Order code	Product number	Weight	Order code	Product number	Weight
Code produit	Référence produit	Poids	Code produit	Référence produit	Poids
Código del producto	Referencia del producto	Peso	Código del producto	Referencia del producto	Peso
Модель	Номер продукции	Вес	Модель	Номер продукции	Вес
		[kg]			[kg]

HEXAAGONAL SHAFT

Round · ronds · esféricos · сферическими

Hexaagonal 7 mm Round	06K-03-0805	0,06
Hexaagonal 8 mm Round	06K-03-0804	0,06
Hexaagonal 9 mm Round	06K-03-0803	0,06
Hexaagonal 10 mm Round	06K-03-0812	0,07
Hexaagonal 11 mm Round	06K-03-0811	0,07
Hexaagonal 12 mm Round	06K-03-0810	0,07
Hexaagonal 13 mm Round	06K-03-0809	0,07
Hexaagonal 14 mm Round	06K-03-0808	0,08
Hexaagonal 16 mm Round	06K-03-0806	0,08
Hexaagonal 18 mm Round	06K-03-3412	0,09

HEXAAGONAL SHAFT

Ballistic · balistiques · balísticos · баллистическими

Hexaagonal 7 mm Ballistic	06K-03-0715	0,06
Hexaagonal 8 mm Ballistic	06K-03-0710	0,06
Hexaagonal 9 mm Ballistic	06K-03-2174	0,06
Hexaagonal 10 mm Ballistic	06K-03-0739	0,07
Hexaagonal 11 mm Ballistic	06K-03-0734	0,07
Hexaagonal 12 mm Ballistic	06K-03-2176	0,07
Hexaagonal 13 mm Ballistic	06K-03-0728	0,07
Hexaagonal 14 mm Ballistic	06K-03-0724	0,08
Hexaagonal 16 mm Ballistic	06K-03-0721	0,08
Hexaagonal 18 mm Ballistic	06K-03-3413	0,09



Sandrive shaft



Wingdrive shaft



Hexaagonal shaft



INDEX

Index · Índice · Спецификации

Product number	Order code	Page	Product number	Order code	Page	Product number	Order code	Page
01-238-055-5604	HTG 38C55S	36	01-238-089-4273	HTG 38C89DS	37	01-245-089-3742	HTG 45C89DSR	42
01-238-055-5605	HTG 38C55S	36	01-238-089-4344	HTG 38C89DSR	37	01-245-089-3743	HTG 45C89DSR	42
01-238-060-3750	HTG 38C60DSR	36	01-238-089-4345	HTG 38C89DSR	37	01-245-089-4081	HTG 45C89DS	42
01-238-060-3751	HTG 38C60DSR	36	01-238-102-3520	HTG 38C102 Dome	33	01-245-089-4082	HTG 45C89DS	42
01-238-060-4063	HTG 38C60DS	36	01-238-127-3946	HTG 38C127 Dome	33	01-245-102-2210	HTG 45C102DSR	42
01-238-060-4064	HTG 38C60DS	36	01-238-153-3476	HTG 38C153 Dome	33	01-245-102-2211	HTG 45C102DSR	42
01-238-064-1034	HTG 38C64AR	36	01-238-238-1112	Guide adapter MF-38C62-410	82	01-245-102-2555	HTG 45C102DS	42
01-238-064-1038	HTG 38C64AR	36	01-245-070-3695	HTG 45C70DSR	41	01-245-102-3058	HTG 45C102DS	42
01-238-064-2244	HTG 38C64A	36	01-245-070-3696	HTG 45C70DSR	41	01-245-180-5212	HTG 45C180 Dome	33
01-238-064-2245	HTG 38C64A	36	01-245-070-4035	HTG 45C70DS	41	01-245-220-4250	HTG 45C220 Dome	33
01-238-064-2386	HTG 38C64DSR	36	01-245-070-4036	HTG 45C70DS	41	01-245-245-2345	Guide adapter MF-45C72-410	82
01-238-064-2387	HTG 38C64DSR	36	01-245-076-2081	HTG 45C76B	41	01-245-245-3282	Guide adapter MF-45C68-410	82
01-238-064-4060	HTG 38C64DS	36	01-245-076-2082	HTG 45C76B	41	01-251-083-3739	HTG 51C83DSR	46
01-238-064-4061	HTG 38C64DS	36	01-245-076-2168	HTG 45C76AR	41	01-251-083-3740	HTG 51C83DSR	46
01-238-070-3690	HTG 38C70DSR	36	01-245-076-2169	HTG 45C76AR	41	01-251-083-4084	HTG 51C83DS	46
01-238-070-3691	HTG 38C70DSR	36	01-245-076-2350	HTG 45C76A	41	01-251-083-4085	HTG 51C83DS	46
01-238-070-4069	HTG 38C70DS	36	01-245-076-2351	HTG 45C76A	41	01-251-089-1240	HTG 51C89AR	46
01-238-070-4070	HTG 38C70DS	36	01-245-076-3720	HTG 45C76DSR	41	01-251-089-1243	HTG 51C89AR	46
01-238-076-1077	HTG 38C76B	37	01-245-076-3721	HTG 45C76DSR	41	01-251-089-1247	HTG 51C89B	46
01-238-076-1080	HTG 38C76B	37	01-245-076-4072	HTG 45C76DS	41	01-251-089-1249	HTG 51C89B	46
01-238-076-2048	HTG 38C76A	37	01-245-076-4073	HTG 45C76DS	41	01-251-089-1251	HTG 51C89BR	46
01-238-076-2049	HTG 38C76A	37	01-245-083-3733	HTG 45C83DSR	42	01-251-089-1253	HTG 51C89BR	46
01-238-076-2157	HTG 38C76AR	37	01-245-083-3734	HTG 45C83DSR	42	01-251-089-2104	HTG 51C89A	46
01-238-076-2158	HTG 38C76AR	37	01-245-083-4075	HTG 45C83DS	41	01-251-089-2105	HTG 51C89A	46
01-238-076-4066	HTG 38C76DS	37	01-245-083-4076	HTG 45C83DS	41	01-251-089-3745	HTG 51C89DSR	46
01-238-076-4067	HTG 38C76DS	37	01-245-089-1169	HTG 45C89A	42	01-251-089-3746	HTG 51C89DSR	46
01-238-089-2093	HTG 38C89DR	37	01-245-089-1172	HTG 45C89A	42	01-251-089-4038	HTG 51C89DS	46
01-238-089-2192	HTG 38C89A	37	01-245-089-1176	HTG 45C89AR	42	01-251-089-4039	HTG 51C89DS	46
01-238-089-2193	HTG 38C89A	37	01-245-089-1180	HTG 45C89AR	42	01-251-102-1284	HTG 51C102DSR	47
01-238-089-2979	HTG 38C89 Dome	33	01-245-089-1182	HTG 45C89B	42	01-251-102-1287	HTG 51C102DSR	47
01-238-089-4272	HTG 38C89DS	37	01-245-089-1184	HTG 45C89B	42	01-251-102-2060	HTG 51C102DS	47
						01-251-102-2061	HTG 51C102DS	47



Product number	Order code	Page	Product number	Order code	Page	Product number	Order code	Page
01-251-102-2063	HTG 51C102A	47	01-368-102-2201	HTG 68CT102DS	57	01-460-127-2998	HTG 60RG127DS	54
01-251-102-2064	HTG 51C102A	47	01-368-102-2202	HTG 68CT102DS	57	01-460-127-3035	HTG 60RG127A	54
01-251-102-2559	HTG 51C102AR	47	01-368-115-2576	HTG 68CT115DS	57	01-460-127-3037	HTG 60RG127AR	54
01-251-102-2732	HTG 51C102AR	47	01-368-115-3408	HTG 68CT115DS	57	01-460-140-2571	HTG 60RG140A	54
01-251-115-2066	HTG 51C115DSR	47	01-368-115-3409	HTG 68CT127DS	57	01-460-140-2572	HTG 60RG140DS	54
01-251-115-2067	HTG 51C115DSR	47	01-368-127-2577	HTG 68CT127DS	57	01-460-140-2573	HTG 60RG140AR	54
01-251-115-2110	HTG 51C115A	47	01-460-095-1375	HTG 60RG95AR	53	01-460-140-2584	HTG 60RG140DSR	55
01-251-115-2111	HTG 51C115A	47	01-460-095-1376	HTG 60RG95AR	53	01-460-140-2585	HTG 60RG140DSR	55
01-251-115-2160	HTG 51C115DS	47	01-460-102-2204	HTG 60RG102AR	53	01-460-140-3399	HTG 60RG140A	54
01-251-115-2161	HTG 51C115DS	47	01-460-102-2205	HTG 60RG102AR	53	01-460-140-3400	HTG 60RG140DS	54
01-251-115-2346	HTG 51C115AR	47	01-460-102-2253	HTG 60RG102DSR	53	01-460-140-3401	HTG 60RG140AR	54
01-251-115-2347	HTG 51C115AR	47	01-460-102-2254	HTG 60RG102DSR	53	01-460-152-2574	HTG 60RG152A	55
01-251-127-2069	HTG 51C127DS	48	01-460-102-2562	HTG 60RG102A	53	01-460-152-2575	HTG 60RG152DS	55
01-251-127-2070	HTG 51C127DS	48	01-460-102-2563	HTG 60RG102DS	53	01-460-152-3402	HTG 60RG152A	55
01-251-127-2072	HTG 51C127DSR	48	01-460-102-3395	HTG 60RG102A	53	01-460-152-3403	HTG 60RG152DS	55
01-251-127-2073	HTG 51C127DSR	48	01-460-102-3396	HTG 60RG102DS	53	04-012-089-0285	Reamer 89	32
01-251-127-2313	HTG 51C127A	48	01-460-115-2564	HTG 60RG115A	53	04-012-102-0286	Reamer 102	32
01-251-127-2314	HTG 51C127A	48	01-460-115-2565	HTG 60RG115DS	53	04-012-127-0287	Reamer 127	32
01-251-251-1315	Guide adapter MF-51C79-410	82	01-460-115-2566	HTG 60RG115AR	53	04-012-140-3493	Reamer 140	32
01-251-251-3153	Guide adapter MF-51C96-410	82	01-460-115-2567	HTG 60RG115DSR	54	04-125-035-2362	HTG 25R35M	16
01-251-251-3531	Guide adapter MF-51C83-410	82	01-460-115-3001	HTG 60RG115DS	53	04-125-035-2363	HTG 25R35M	16
01-358-092-4332	HTG 58C92DSR	52	01-460-115-3056	HTG 60RG115DSR	54	04-125-038-2011	HTG 25R38M	16
01-358-092-4333	HTG 58C92DSR	52	01-460-115-3397	HTG 60RG115A	53	04-125-038-2012	HTG 25R38M	16
01-358-102-2495	HTG 58C102DSR	52	01-460-115-3398	HTG 60RG115AR	53	04-125-041-2178	HTG 25R41M	16
01-358-102-2496	HTG 58C102DSR	52	01-460-127-2075	HTG 60RG127DSR	54	04-125-041-2179	HTG 25R41M	16
01-358-115-2560	HTG 58C115DSR	52	01-460-127-2076	HTG 60RG127DSR	54	04-128-038-2020	HTG 28R38M	17
01-358-115-3394	HTG 58C115DSR	52	01-460-127-2568	HTG 60RG127A	54	04-128-038-2021	HTG 28R38M	17
01-358-127-2561	HTG 58C127DSR	52	01-460-127-2569	HTG 60RG127DS	54	04-128-041-2552	HTG 28R41M	17
01-358-127-2734	HTG 58C127DSR	52	01-460-127-2570	HTG 60RG127AR	54	04-128-041-2618	HTG 28R41M	17
						04-132-041-2023	HTG 32R41M	18



INDEX

Index · Índice · Спецификации

Product number	Order code	Page	Product number	Order code	Page	Product number	Order code	Page
04-132-041-2024	HTG 32R41M	18	04-132-127-3393	HTG 32R127 Dome	32	06B-07-0501	MF-C45-46R-C45-3660	43
04-132-043-2029	HTG 32R43A	18	04-132-132-0410	Pilot adapter R32/R32	32	06B-07-0502	MF-RG60-60R-RG60-4265	56
04-132-043-2030	HTG 32R43A	18	04-132-132-0410	Pilot adapter R32/R32	32	06B-07-2199	MF-C38-39R-C38-3050	38
04-132-043-3836	HTG 32R43S	18	04-135-048-3725	HTG 35R48S	26	06B-07-2419	MF-R32-32R-R32-1525-FC	23
04-132-043-3837	HTG 32R43S	18	04-135-048-3726	HTG 35R48S	26	06B-07-2420	MF-C38-39R-C38-1525-FC	38
04-132-045-0329	HTG 32R45A	18	04-135-051-4413	HTG 35R51SR	26	06B-07-2421	MF-C45-46R-C45-1525-FC	43
04-132-045-0331	HTG 32R45A	18	04-135-051-4414	HTG 35R51SR	26	06B-07-2491	MF-C38-39R-C38-3660	38
04-132-045-3805	HTG 32R45S	18	04-135-051-4682	HTG 35R51S	26	06B-07-2492	MF-R32-32R-R32-3660	23
04-132-045-3806	HTG 32R45S	18	04-135-051-4683	HTG 35R51S	26	06B-07-2876	MF-R32-32R-R32-1220-FC	23
04-132-045-3818	HTG 32R45SR	18	04-135-054-4131	HTG 35R54SR	26	06B-07-2877	MF-R32-32R-R32-3050	23
04-132-045-3819	HTG 32R45SR	18	04-135-054-4132	HTG 35R54SR	26	06B-07-2879	MF-C38-39R-C38-1830-FC	38
04-132-048-3815	HTG 32R48S	18	04-135-054-4734	HTG 35R54S	26	06B-07-2882	MF-C45-46R-C45-3050	43
04-132-048-3816	HTG 32R48S	18	04-135-054-4735	HTG 35R54S	26	06B-07-2883	MF-C51-52R-C51-1830-FC	49
04-132-051-0357	HTG 32R51A	18	04-135-135-0464	Pilot adapter R35/R35	32	06B-07-2884	MF-C51-52R-C51-4265	49
04-132-051-0359	HTG 32R51A	18	04-135-135-0464	Pilot adapter R35/R35	32	06B-07-2910	MF-R32-32R-R32-0915-FC	23
04-132-051-3821	HTG 32R51S	19	06A-07-0489	MM-C45-46R-C45-3050	44	06B-07-2911	MF-C38-39R-C38-1220-FC	38
04-132-051-3822	HTG 32R51S	19	06A-07-0491	MM-C38-39R-C38-3660	39	06B-07-2912	MF-C45-46R-C45-4265	43
04-132-051-4590	HTG 32R51SR	19	06A-07-0492	MM-C38-39R-C38-3050	39	06B-07-3019	MF-C45-46R-C45-1830-FC	43
04-132-051-4591	HTG 32R51SR	19	06A-07-2536	MM-C51-52R-C51-3660	50	06B-07-3020	MF-R32-32R-R32-1830-FC	23
04-132-057-5602	HTG 32R57S	19	06A-07-2899	MM-R32-32R-R32-1220-FC	24	06B-07-3243	MF-C38-39R-C38-4265	38
04-132-057-5603	HTG 32R57S	19	06A-07-2900	MM-R32-32R-R32-1525-FC	24	06B-07-3244	MF-C45-46R-C45-6095	43
04-132-064-0385	HTG 32R64AR	19	06A-07-2901	MM-R32-32R-R32-1830-FC	24	06B-07-3245	MF-C51-52R-C51-6095	49
04-132-064-0387	HTG 32R64AR	19	06A-07-2905	MM-C45-46R-C45-3660	44	06B-07-3248	MF-C51-52R-C51-1525-FC	49
04-132-064-2037	HTG 32R64A	19	06A-07-2906	MM-C45-46R-C45-4265	44	06B-07-3358	MF-RG60-60R-RG60-3660	56
04-132-064-2038	HTG 32R64A	19	06A-07-2909	MM-C51-52R-C51-4265	50	06B-07-3359	MF-RG60-60R-RG60-6095	56
04-132-076-0398	HTG 32R76B	19	06A-07-3241	MM-R32-32R-R32-3050	24	06D-07-0891	MM-C38-35H-R32-4305	21
04-132-076-0400	HTG 32R76B	19	06A-07-3242	MM-R32-32R-R32-3660	24	06D-07-2143	MM-R38-32H-R32-4305	20
04-132-089-2265	HTG 32R89 Dome	33	06A-07-3246	MM-C51-52R-C51-6095	50	06D-07-2709	MM-R38-35H-R32-4305	20
04-132-089-2266	HTG 32R89 Dome	33	06A-07-3247	MM-R32-32R-R32-0915-FC	24	06D-07-2750	MM-C38-32H-R32-4305	21
04-132-102-2268	HTG 32R102 Dome	33	06B-07-0500	MF-C51-52R-C51-3660	49	06D-07-2886	MM-R38-32H-R32-3090	20
04-132-102-2269	HTG 32R102 Dome	33				06D-07-2887	MM-R38-32H-R32-3700	20
04-132-127-2938	HTG 32R127 Dome	33						



Product number	Order code	Page	Product number	Order code	Page	Product number	Order code	Page
06D-07-2889	MM-C38-32H-R32-3090	21	06E-07-0889	Coupling C45	84	06F-07-0482	HL 650-52 (700-52 / PE-52 / S-52,	
06D-07-2892	MM-R38-35H-R32-3090	20	06E-07-2311	C38 F-C45 M	83		710-52 / S-52 / PE-52 / SPE-52,	
06D-07-2894	MM-R38-35H-R32-3700	20	06E-07-2660	Coupling R38-R32	85		800T-52 / PE-52)	76
06D-07-2895	MM-C38-35H-R32-3090	21	06E-07-2853	Coupling C51-D72	51	06F-07-0483	HL 500-45 / 510-45	73
06D-07-2897	MM-C38-35H-R32-3700	21	06E-07-2853	Coupling C51	84	06F-07-0487	COP 1432, COP 1532, COP1440,	
06D-07-3021	MM-C38-35H-R35-4305	27	06E-07-2854	Coupling C45	84		COP1838 HD/ME)	64
06D-07-3965	MM-C38-35H-R32-4915	21	06E-07-2855	Coupling R28	84	06F-07-2032	HC 120R, HC 150R, HC 155R,	
06D-07-3966	MM-C38-35H-R32-5525	21	06E-07-2856	Coupling R25	84		HC 158R	71
06D-07-3974	MM-C38-39R-R35-5525	28	06E-07-2857	Coupling R32-R25	85	06F-07-2144	HC 80, HC 90, HC 105	70
06D-07-3975	MM-C38-39R-R35-6135	28	06E-07-2863	Coupling C38-R32	85	06F-07-2182	HL 650-52 (700-52 / PE-52 / S-52,	
06D-07-3976	MM-C38-39R-R35-6440	28	06E-07-2865	Coupling C38-R38	85		710-52 / S-52 / PE-52 / SPE-52,	
06D-07-4057	MM-C38-35H-R35-5525	27	06E-07-2869	R32 F-R38 M	83		800T-52 / PE-52)	76
06D-07-4348	MM-C38-35H-R35-3090	27	06E-07-2870	R32 F-C38 M	83	06F-07-2198	HL 300S	72
06D-07-4349	MM-C38-35H-R35-3700	27	06E-07-2871	R38 F-R32 M	83	06F-07-2200	HD 712	68
06D-07-4350	MM-C38-35H-R35-4915	27	06E-07-2872	R38 F-C38 M	83	06F-07-2331	HL 650-52 (700-52 / PE-52 / S-52,	
06D-07-4351	MM-C38-35H-R35-6440	27	06E-07-2873	C38 F-R38 M	83		710-52 / S-52 / PE-52 / SPE-52,	
06D-07-4352	MM-C38-39R-R35-4305	28	06E-07-2874	C45 F-C51 M	83		800T-52 / PE-52)	76
06D-07-4353	MM-C38-39R-R35-4915	28	06E-07-2875	C51 F-C45 M	83	06F-07-2334	HLX 5 / HLX 5T	75
06D-07-6135	MM-C38-35H-R35-6135	27	06E-07-3386	Coupling R28-R25	85	06F-07-2335	HL 500 S-38 / 510 S-38 / 510 B /	
06E-07-0494	Coupling C51-D77	51	06E-07-3387	Coupling R32-R28	85		510 LH	74
06E-07-0494	Coupling C51	84	06E-07-3388	Coupling C45-C38	85	06F-07-2337	COP 1550, COP 1838 ME/ HE	65
06E-07-0495	Coupling R38	22	06E-07-3389	Coupling C51-C45	85	06F-07-2371	HL 500 S-38 / 510 S-38 / 510 B /	
06E-07-0495	Coupling R38	84	06E-07-3405	R25 F-R28 M	83		510 LH	74
06E-07-0496	Coupling R32	25	06E-07-3406	R25 F-R32 M	83	06F-07-2429	COP 1038 HD/1238	63
06E-07-0496	Coupling R32	84	06E-07-3407	R28 F-R32 M	83	06F-07-2430	COP 1038 HD/1238	63
06E-07-0497	Coupling C38	22	06F-07-0472	COP 1840 HE, COP 1850	65	06F-07-2431	COP 1432, COP 1532, COP1440,	
06E-07-0497	Coupling C38	40	06F-07-0476	YH 65, YH 80	69		COP1838 HD/ME)	64
06E-07-0497	Coupling C38	84	06F-07-0478	PD 200R	67	06F-07-2432	COP 1432, COP 1532, COP1440,	
06E-07-0499	C38 F-R32 M	83	06F-07-0480	PD 200	67		COP1838 HD/ME)	64
06E-07-0838	C45 F-C38 M	83	06F-07-0480	URD 475 (URD 550, VL120,		06F-07-2434	HC 80, HC 90, HC 105	70
06E-07-0889	Coupling C45	45		EVL 130, VL140 and F16)	69	06F-07-2494	HL 500-45 / 510-45	73



INDEX

Index · Índice · Спецификации

Product number	Order code	Page	Product number	Order code	Page	Product number	Order code	Page
06F-07-2527	HL 500-45 / 510-45	73	06F-07-2791	HLX 5 / HLX 5T	75	06F-07-2838	COP 1550, COP 1838 ME/ HE	65
06F-07-2662	COP 1432, COP 1532, COP1440, COP1838 HD/ME)	64	06F-07-2792	HLX 5 / HLX 5T	75	06F-07-2839	COP 1550, COP 1838 ME/ HE	65
06F-07-2713	YH 65, YH 80	69	06F-07-2793	HLX 5 / HLX 5T	75	06F-07-2840	COP 1840 HE, COP 1850	65
06F-07-2714	YH 80 A	69	06F-07-2794	HLX 5 / HLX 5T	75	06F-07-2841	COP 1840 HE, COP 1850	65
06F-07-2715	HC 80R (HC 105R, HC 107R, HC 108R, HC 109R)	70	06F-07-2795	HLX 5 / HLX 5T	75	06F-07-2844	HD 609	68
06F-07-2719	COP 1432, COP 1532, COP1440, COP1838 HD/ME)	64	06F-07-2796	HL 600-45 / 600 S-45	75	06F-07-2845	HD 609	68
06F-07-2720	COP 1038 HD/1238	63	06F-07-2797	HL 600-45 / 600 S-45	75	06F-07-2846	HD 709	68
06F-07-2721	HL 500 S-38 / 510 S-38 / 510 B / 510 LH	74	06F-07-2798	HL 600-45 / 600 S-45	75	06F-07-2849	HC40	70
06F-07-2740	COP 1840 HEX, COP 1850 EX	66	06F-07-2799	HL 600-45 / 600 S-45	75	06F-07-3118	COP 1132	64
06F-07-2741	HC40	70	06F-07-2800	HL 600-45 / 600 S-45	75	06F-07-3186	HL 1000 PE-65 / HL 1500 PE-65 / HL 1560 T-65	78
06F-07-2742	HD 612	68	06F-07-2801	HL 600-52	76	06F-07-3187	BBC 43, 44, 45 and 100	61
06F-07-2743	HC 200	71	06F-07-2802	HL 600-52	76	06F-07-3188	BBC 51, 52, 54 and 120	61
06F-07-2771	HL 300	72	06F-07-2803	HL 645	76	06F-07-3189	BBC 51, 52, 54 and 120	61
06F-07-2776	L400, L410, L500, L510, L550	72	06F-07-2804	HL 645	76	06F-07-3190	BBE 57	61
06F-07-2777	HLR 438L and HLR 438T	72	06F-07-2805	HL 650-45 / 700-45 / 700T-45 / 710-45 / 800T-45	76	06F-07-3191	COP 125, 130 and 131	61
06F-07-2778	HLR 438L and HLR 438T	72	06F-07-2806	HL 650-45 / 700-45 / 700T-45 / 710-45 / 800T-45	76	06F-07-3193	COP 1032 HD	62
06F-07-2780	HLR 438LS, 438TS, HL 538, HL538L, L550S	73	06F-07-2810	HL 850S	77	06F-07-3194	COP 1032 HD	62
06F-07-2781	HLR 438LS, 438TS, HL 538, HL538L, L550S	73	06F-07-2811	HL 1000-52 / 1000 S-52	77	06F-07-3195	COP 1032 LE	62
06F-07-2783	HLR 438LS, 438TS, HL 538, HL538L, L550S	73	06F-07-2812	HL 1000-52 / 1000 S-52	77	06F-07-3196	COP 1550 EX, COP 1838 EX	65
06F-07-2787	HL 500 S-38 / 510 S-38 / 510 B / 510 LH	74	06F-07-2813	HL 1000-52 / 1000 S-52	77	06F-07-3197	COP 1550 EX, COP 1838 EX	65
06F-07-2788	HL 500 S-38 / 510 S-38 / 510 B / 510 LH	74	06F-07-2814	HL 1000-52 / 1000 S-52	77	06F-07-3198	PD 200	67
06F-07-2789	HL 550 SUPER / 560 SUPER / 510 S-45	74	06F-07-2815	HL 1000-60	77	06F-07-3198	URD 475 (URD 550, VL120, EVL 130, VL140 and F16)	69
06F-07-2790	HL 550 SUPER / 560 SUPER / 510 S-45	74	06F-07-2816	HL 1500-52 / 1500 T-52	78	06F-07-3199	PD 200	67
			06F-07-2820	COP 1036/1238/1038 HB	62	06F-07-3199	URD 475 (URD 550, VL120, EVL 130, VL140 and F16)	69
			06F-07-2822	COP 1036/1238/1038 HB	62	06F-07-3200	HD 300	67
			06F-07-2823	COP 1036/1238/1038 HB	62	06F-07-3201	HD 300	67
			06F-07-2828	COP 1038 HL/1238	63	06F-07-3202	HD 609	68
			06F-07-2829	COP 1038 HL/1238	63			
			06F-07-2833	COP 1238	64			
			06F-07-2834	COP 1038 HL/1238	63			



Product number	Order code	Page	Product number	Order code	Page	Product number	Order code	Page
06F-07-3204	HC 80, HC 120	71	06K-03-0721	Hexaconal 16 mm Ballistic	87	06K-21-0735	Sandrive 11 mm Ballistic	86
06F-07-3205	HC 200A	71	06K-03-0724	Hexaconal 14 mm Ballistic	87	06K-21-0736	Wingdrive 11 mm Ballistic	86
06F-07-3232	HL 1000 PE-65 / HL 1500 PE-65 / HL 1560 T-65	78	06K-03-0728	Hexaconal 13 mm Ballistic	87	06K-21-0740	Sandrive 10 mm Ballistic	86
06F-07-3360	HL 1000-60	77	06K-03-0734	Hexaconal 11 mm Ballistic	87	06K-21-0741	Wingdrive 10 mm Ballistic	86
06F-07-3361	HL 500 F / 510 F	74	06K-03-0739	Hexaconal 10 mm Ballistic	87	06K-21-0745	Wingdrive 16 mm Ballistic	86
06F-07-3363	HL 1500-60 / 1500 T-60	78	06K-03-0803	Hexaconal 9 mm Round	87	06K-21-0746	Wingdrive 13 mm Ballistic	86
06F-07-3364	HL 1500-60 / 1500 T-60	78	06K-03-0804	Hexaconal 8 mm Round	87	06K-21-0747	Sandrive 9 mm Round	86
06F-07-3371	COP 1432 Female	64	06K-03-0805	Hexaconal 7 mm Round	87	06K-21-0748	Wingdrive 9 mm Round	86
06F-07-3372	COP 1432 Female	64	06K-03-0806	Hexaconal 16 mm Round	87	06K-21-0750	Sandrive 8 mm Round	86
06F-07-3373	COP 1840 HEX, COP 1850 EX	66	06K-03-0808	Hexaconal 14 mm Round	87	06K-21-0751	Wingdrive 8 mm Round	86
06F-07-3374	COP 2150, COP 2550	66	06K-03-0809	Hexaconal 13 mm Round	87	06K-21-0756	Wingdrive 18 mm Round	86
06F-07-3375	COP 2160 EX, COP 2560 EX	66	06K-03-0810	Hexaconal 12 mm Round	87	06K-21-0758	Sandrive 18 mm Round	86
06F-07-3376	COP 2160 EX, COP 2560 EX	66	06K-03-0811	Hexaconal 11 mm Round	87	06K-21-0760	Sandrive 16 mm Round	86
06F-07-3377	URD 475 (URD 550, VL120, EVL 130, VL140 and F16)	69	06K-03-0812	Hexaconal 10 mm Round	87	06K-21-0761	Wingdrive 16 mm Round	86
06F-07-3380	HC40 (female)	70	06K-03-2174	Hexaconal 9 mm Ballistic	87	06K-21-0766	Sandrive 14 mm Round	86
06F-07-3381	HC 80, HC 90, HC 105	70	06K-03-2176	Hexaconal 12 mm Ballistic	87	06K-21-0767	Wingdrive 14 mm Round	86
06F-07-3382	H 100	70	06K-03-3412	Hexaconal 18 mm Round	87	06K-21-0770	Sandrive 13 mm Round	86
06F-07-3432	HLR 438LS, 438TS, HL 538, HL538L, L550S	73	06K-03-3412	Hexaconal 18 mm Ballistic	87	06K-21-0771	Wingdrive 13 mm Round	86
06F-07-4450	YH 65 RP (YH 70 RP, YH 75 RP, YH 80 RP)	69	06K-21-0707	Sandrive 9 mm Ballistic	86	06K-21-0775	Sandrive 12 mm Round	86
06F-07-5460	HL 1500-80 / HL 1500 T-80	78	06K-21-0708	Wingdrive 9 mm Ballistic	86	06K-21-0776	Wingdrive 12 mm Round	86
06F-07-5599	COP 3038	66	06K-21-0711	Sandrive 8 mm Ballistic	86	06K-21-0779	Sandrive 11 mm Round	86
06F-07-5600	COP 3038	66	06K-21-0712	Wingdrive 8 mm Ballistic	86	06K-21-0780	Wingdrive 11 mm Round	86
06K-03-0710	Hexaconal 8 mm Ballistic	87	06K-21-0716	Sandrive 7 mm Ballistic	86	06K-21-0782	Sandrive 10 mm Round	86
06K-03-0715	Hexaconal 7 mm Ballistic	87	06K-21-0717	Wingdrive 7 mm Ballistic	86	06K-21-0783	Wingdrive 10 mm Round	86
			06K-21-0720	Sandrive 18 mm Ballistic	86	06K-21-0899	Wingdrive 7 mm Round	86
			06K-21-0722	Sandrive 16 mm Ballistic	86	06K-21-3410	Sandrive 7 mm Round	86
			06K-21-0725	Sandrive 14 mm Ballistic	86	06K-21-3411	Wingdrive 18 mm Ballistic	86
			06K-21-0726	Wingdrive 14 mm Ballistic	86	06L-24-0608	Pilot adapter R35 Chisel	32
			06K-21-0729	Sandrive 13 mm Ballistic	86	06L-24-0608	Pilot adapter R35 Chisel	32
			06K-21-0731	Sandrive 12 mm Ballistic	86	06L-24-0609	Pilot adapter R32 Chisel	32
			06K-21-0732	Wingdrive 12 mm Ballistic	86	06L-24-0609	Pilot adapter R32 Chisel	32

ROBIT ROCKTOOLS PRODUCT CATALOGUE
Catalogue and company information also
available in internet:
www.robit.fi

ROBIT PLC
Vikkiniityntie 9
FI-33880 LEMPÄÄLÄ (TAMPERE)
FINLAND

Tel: +358 3 3140 3400
Fax: +358 3 367 0540
E-mail: robit@robit.fi
<http://www.robit.fi>

Your distributor:



Robit reserves all rights to any changes in the products and the specifications without prior notice.
Printed: June 2016
Copyright © 2016 by Robit Plc

Robit®